

**CA/CAT EN 733 ~ 2900 r.p.m.**  
**CAX/CATX EN 733 ~ 2900 r.p.m.**  
**4CA/4CAT EN 733 ~ 1450 r.p.m.**  
**4CAX/4CATX EN 733 ~ 1450 r.p.m.**

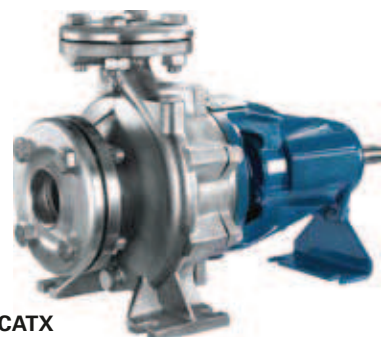

**CA/CAT**  
**4CA/4CAT**



**CAX/CATX**  
**4CAX/4CATX**

Centrifugalne pumpe bez elektromotora konstruirane prema EN 733 standardu; široko se koristi u vodoopskrbi, protupožarnim sistemima, standardna isporuka sa protu prirubnicom

**KONSTRUKCIJSKE KARAKTERISTIKE**

TIJELO PUMPE ljevano željezo - inox AISI 316

NOSAČ MOTORA Lijevano željezo

ROTOR Lijevano željezo, inox 316, bronca

BRTVA keramika - grafit

OSOVINA inox AISI 316

TEMPERATURA TEKUĆINE -10 - +90 °C  
na zahtjev  
do 120 °C

RADNI TLAK max 10 bar

**MOTOR**

DOSTUPNO SA IE3 MOTORIMA ILI STANDARDNIMA

**~ 2900 r.p.m. CA/CAT - CAX/CATX EN 733**  
**~ 1450 r.p.m. 4CA/4CAT - 4CAX/4CATX EN 733**

RAZLIČITE VERZIJE KONSTRUKCIJE

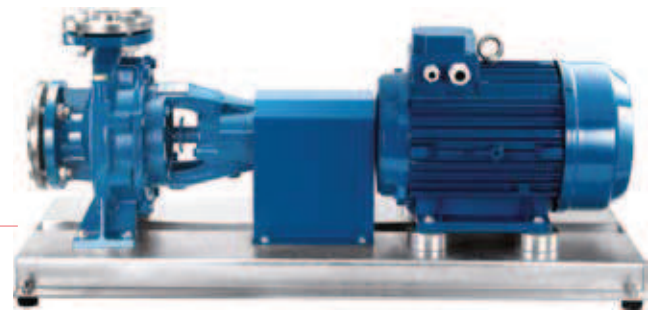
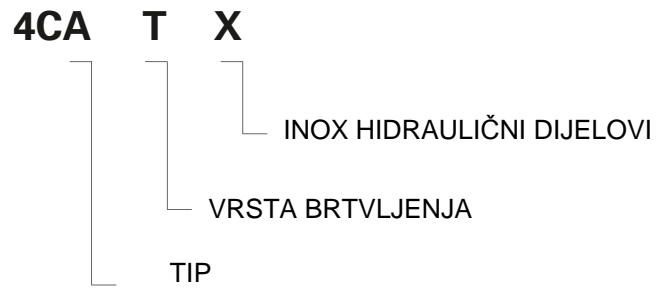
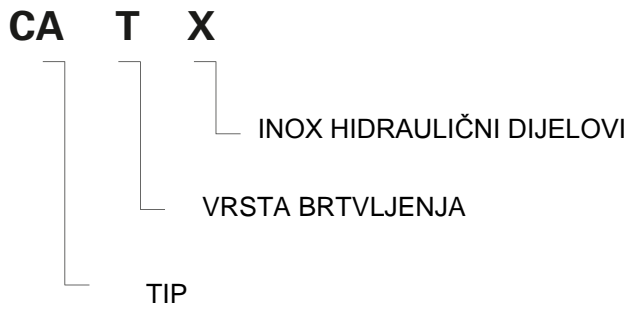

CA/CAT  
4CA/4CAT

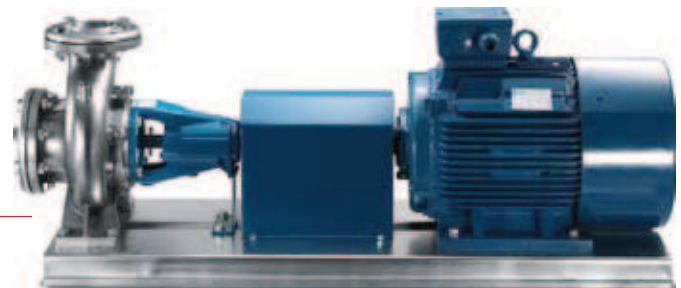

CAX/CATX  
4CAX/4CATX

CA/CAX  
MEHANIČKA BRTVA



CAT/CATX 4CAT/  
4CATX

BRTVENA  
PLETENICA



**CA/CAT - CAX/CATX EN 733 ~ 2900 r.p.m.**

TYPE	Nominal Power (kW)	Motor Size	Q (m³/h - l/min)														
			0	4,5	6	7,5	9	12	15	18	21	24	27	30	33		
			0	75	100	125	150	200	250	300	350	400	450	500	550		
			H (m)														
			pump input power (kW)														
32-160C	1,5	90S	24,7	24,4	24,1	23,6	23,0	21,5	19,6	17,2	14,1						
	2,2	90L	0,69	0,96	1,15	1,26	1,40	1,50	1,55	1,70	1,74						
32-160B	2,2	90L	29,0		28,5	28,0	27,3	25,7	23,8	21,4	18,5	14,8					
			0,93		1,36	1,50	1,67	1,83	1,99	2,15	2,24	2,32					
32-160A	3	100L	36,8		36,4	36,0	35,4	34,2	32,8	31,1	28,8	26,0	22,3				
	4	112M	1,36		1,87	2,05	2,25	2,50	2,70	2,90	3,10	3,25	3,39				
32-200C	4	112M	40,1		39,7	39,6	39,3	38,3	36,9	35,2	33,0	30,4	27,6				
			1,57		2,2	1,57	2,53	2,84	3,13	3,38	3,61	3,82	4,02				
32-200B	5,5	132S	50,1		50,2	50,1	49,9	49,3	48,0	46,4	44,5	42,4	39,8	37,2			
	7,5	132S	2,17		2,95	3,18	3,38	3,78	4,15	4,49	4,78	5,07	5,38	5,64			
32-200A	7,5	132S	58,6		59,0	58,9	58,8	58,2	57,1	55,5	53,4	51,1	48,4	45,6	42,5		
			2,63		3,53	3,77	4,02	4,49	4,92	5,30	5,66	6,03	6,40	6,68	6,95		
32-250C	11	160M	70,0			68,5	68,0	67,0	65,5	63,5	61	58	50	36,5			
			4,89			6,15	6,48	7,11	7,74	8,19	8,54	8,89	9,24	9,63			
32-250B	11	160M	82,0			81,0	80,5	79,5	78,5	77,0	74,5	71,9	65	52,5			
	15	160M	6,45			8,02	8,35	9,00	9,56	10,1	10,5	11,2	11,8	12,1			
32-250A	15	160M	93,0			92,5	92,0	91,5	90,5	89,5	87,5	85	78,5	66			
			7,85			9,30	9,88	10,7	11,4	12,2	12,9	13,6	14,3	14,9			
40-125C	1,5	90S	18,9				19,0	18,8	18,3	17,7	16,9	15,9	14,7	13,2	11,6		
			0,69				1,05	1,18	1,30	1,40	1,48	1,55	1,60	1,63	1,65		
40-125B	2,2	90L	22,5				22,9	22,8	22,5	21,9	21,2	20,3	19,2	18,0	16,7		
			0,86				1,28	1,45	1,60	1,74	1,86	1,96	2,04	2,10	2,15		
40-125A	3	100L	26,2				26,6	26,5	26,3	25,9	25,2	24,4	23,4	22,2	20,9		
			1,11				1,60	1,79	1,98	2,15	2,30	2,43	2,55	2,66	2,75		
40-160B	3	100L	30,0				30,1	30,0	29,6	29,0	28,2	27,1	25,9	24,4	22,8		
	4	112M	1,39				2,00	2,20	2,38	2,57	2,75	2,91	3,04	3,16	3,26		
40-160A	4	112M	35,4				35,6	35,5	35,3	35,0	34,2	33,2	32,0	30,6	29,0		
	5,5	132S	1,64				2,36	2,55	2,78	3,00	3,21	3,40	3,56	3,72	3,86		
40-200B	5,5	132S	44,7				44,9	44,8	44,6	44,0	42,9	41,6	40,0	38,1	36,1		
			2,30				3,30	3,60	3,80	4,20	4,60	4,60	5,00	5,30	5,40		
40-200A	7,5	132S	57,7				57,7	57,5	57,1	56,3	55,4	54,1	52,5	50,5	48,5		
			3,20				4,30	4,60	5,20	5,60	6,10	6,40	6,70	7,10	7,40		
40-250C	11	160M	63,0				62,6	62,4	61,9	61,3	60,5	59,7	58,6	57,1	55,0		
			4,40				5,60	6,08	6,61	7,13	7,63	8,10	8,57	9,04	9,45		
40-250B	11	160M	70,8				71,3	71,2	71,0	70,5	69,8	68,4	66,6	65,4	63,8		
	15	160M	5,16				6,65	7,22	7,76	8,28	8,80	9,33	9,86	10,35	10,82		
40-250A	15	160M	86,1				86,3	86,5	86,4	86,0	85,6	85,0	84,1	82,9	81,3		
	18,5	160L	6,70				8,24	8,89	9,58	10,29	10,97	11,65	12,31	12,95	13,55		
50-125B	3	100L	19,9					20,2	20,2	20,1	20,0	19,8	19,3	19,1	18,7		
	4	112M	1,22					1,77	1,94	2,11	2,22	2,33	2,44	2,55	2,65		
50-125A	4	112M	24,5						25,0	24,9	24,8	24,6	24,4	24,2	23,8		
	5,5	132S	1,78						2,54	2,70	2,85	3,01	3,17	3,33	3,42		
50-160B	5,5	132S	31,1								32,1	32,0	31,7	31,4	31,0		
			2,10								3,60	3,80	4,00	4,20	4,40		
50-160A	7,5	132S	36,7								37,9	37,8	37,7	37,4	37,1		
			2,60								4,20	4,50	4,90	5,10	5,40		
50-200C	11	160M	46,0									45,6	45,1	44,5	43,7		
			3,25									6,08	6,30	6,53	6,76		
50-200B	11	160M	50,8									51,0	50,5	50,0	49,3		
			3,38									6,68	7,53	7,80	8,20		
50-200A	15	160M	58,0									58,3	58,0	57,5	57,0		
			4,63									7,89	8,28	8,67	9,08		
50-250C	15	160M	71,5										70,8	70,3	69,7		
	18,5	160L	6,74										11,30	11,90	12,50		
50-250B	18,5	160L	78,0										78,0	77,4	76,8		
	22	180M	6,87										12,00	12,70	13,30		
50-250A	22	180M	90,0										89,5	88,8	88,3		
	30	200L	10,10										15,60	16,30	17,00		
65-125B	5,5	132S	20,9											22,0	22,0		
			2,30											3,60	3,70		
65-125A	7,5	132S	25,4											26,4	26,4		
			2,80											4,10	4,30		
65-160C	11	160M	29,8														
			3,29														
65-160B	11	160M	33,0														
			3,17														
65-160A	15	160M	39,2														
			4,80														
65-200C	15	160M	45,3														
			4,90														
65-200B	18,5	160L	51,6														
			5,40														
65-200A	22	180M	60,2														
			7,60														
65-250B	30	200L	81,0														
			10,60														
65-250A	37	200L	90,0														
			12,30														



**CA/CAT - CAX/CATX EN 733 ~ 2900 r.p.m.**

TYPE	Nominal Power (kW)	Motor Size	Q (m³/h - l/min)									
			0	66	72	78	96	108	120	144	168	
			0	1100	1200	1300	1600	1800	2000	2400	2800	
H (m) pump input power (kW)												
80-160E	11	160M	21,4 3,6	22,4 6,3	22,1 6,6	21,6 6,8	20,2 7,3	19,2 7,6	18,0 8,0	15,4 8,4	12,0 8,4	
80-160D	11	160M	25,4 4,0	26,4 8,0	26,1 8,2	25,7 8,5	24,4 9,1	23,6 9,5	22,5 9,9	20,0 10,5	16,9 10,9	
80-160C	15	160M	29,7 5,2	30,7 9,0	30,5 9,3	30,3 9,7	29,2 10,7	28,1 11,1	27,1 11,7	24,7 12,7	21,5 13,3	
80-160B	18,5	160L	34,0 5,7	35,0 9,1	35,0 10,2	34,8 10,8	34,0 11,6	33,3 12,6	32,5 13,3	30,5 14,6	27,8 15,4	
80-160A	22	180M	38,8 7,3	39,8 12,0	39,7 12,7	39,6 13,3	38,9 14,6	38,2 15,6	37,5 16,5	35,7 18,0	33,2 19,3	
80-200B	30	200L	49,0 9,3				50,6 20,0	50,3 21,3	49,8 22,6	48,6 25,2	46,7 27,5	
80-200A	37	200L	58,0 11,7				59,6 24,4	59,2 25,8	58,6 27,2	57,3 30,0	55,5 33,0	
80-250B	45	225M	77,2 14,00				80,0 30,93	79,0 32,60	77,5 34,34	73,1 37,86	69,0 40,78	
80-250A	55	250M	90,0 16,75				92,8 36,55	91,1 38,57	89,3 40,54	85,4 44,31	80,7 47,80	
80-315BN	90	280M	108,0 21,85			112,4 42,35	112,2 47,49	111,7 50,85	111,1 54,13	109,1 60,24	106,4 65,95	
80-315AN	110	315M	140,5 31,92			141,4 55,48	140,2 61,13	139,2 64,93	138,1 68,78	135,5 76,96	132,5 84,36	
100-200B	45	225M	56,1 21,75					56,8 28,84	56,5 29,75	55,6 31,75	54,5 33,89	
100-200A	55	250M	61,1 24,57					62,2 33,04	61,8 34,05	61,0 36,18	59,9 38,39	
100-250C	55 75	250M 280S	71,9 24,75						73,2 40,12	72,9 43,70	72,2 46,77	
100-250B	75	280S	83,6 29,69						83,7 47,10	83,2 51,01	82,5 54,76	
100-250A	90	280M	93,5 32,72						93,9 51,98	93,4 56,31	92,4 60,59	

**~ 2900 r.p.m. CA/CAT - CAX/CATX EN 733**

Q (m³/h - l/min)										
	180	195	210	225	240	255	270	300	330	360
	3000	3250	3500	3750	4000	4250	4500	5000	5500	6000
H (m) pump input power (kW)										
	15,1									
	10,9									
	19,7	17,2								
	13,5	13,5								
	26,0	23,6	21,0							
	15,8	16,0	16,3							
	31,6	29,4	26,8	23,5						
	19,8	20,3	21,0	20,1						
	45,5	44,8	41,6	38,6						
	28,5	29,6	30,6	31,3						
	54,3	52,7	50,8	48,5	46,1					
	34,5	35,9	37,4	38,3	39,2					
	67,0	64,5	61,8	58,8						
	42,10	43,60	44,94	46,16						
	78,5	75,7	72,4	68,8	65,2					
	49,29	50,93	52,59	54,17	55,50					
	104,9	102,7	100,4	98,3	95,7	90,8				
	68,74	72,14	75,50	78,97	82,35	85,17				
	131,0	128,7	125,8	122,5	121,7	118,5				
	86,98	90,23	94,71	99,35	102,58	106,15				
	53,9	53,1	52,2	51,4	50,4	49,0	47,5	43,8	39,7	
	35,07	36,55	37,81	38,89	39,85	40,76	41,59	42,92	43,82	
	59,5	58,9	58,3	57,4	56,4	55,2	53,8	50,6	46,8	42,5
	39,49	40,87	42,24	43,60	44,97	46,22	47,28	49,05	50,52	51,61
	71,8	71,1	70,3	69,3	67,9	66,4	64,7	61,0		
	48,15	49,89	51,65	53,38	55,05	56,67	58,19	60,99		
	82,1	81,4	80,8	80,0	79,0	77,9	76,4	72,0	67,6	
	56,55	58,55	60,25	61,86	63,51	65,15	66,93	70,90	73,78	
	91,8	90,9	89,9	88,8	87,4	85,8	84,0	80,4	75,8	73,2
	62,70	65,02	66,97	68,83	70,82	72,83	74,73	78,16	81,33	85,53

**CA/CAT - CAX/CATX EN 733 ~ 2900 r.p.m.**

# 32-160

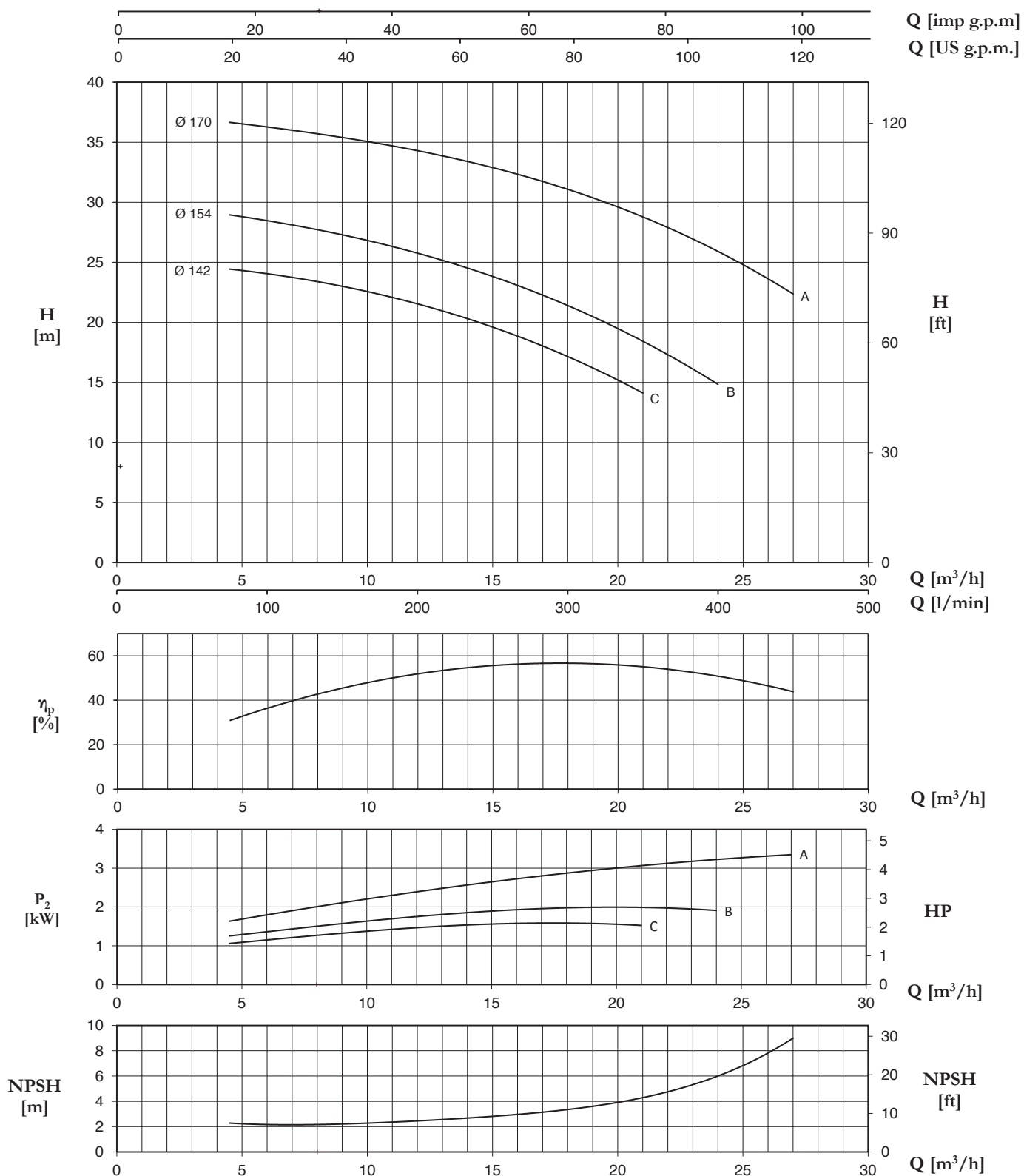

Tolerance: ISO 9906:2012 - Grade 3B

TYPE	Nominal Power (kW)	Motor Size	Q (m³/h - l/min)										
			0	4,5	6	7,5	9	12	15	18	21	24	27
			0	75	100	125	150	200	250	300	350	400	450
H (m) / pump input power (kW)													
32-160C	1,5	90S	24,7	24,4	24,1	23,6	23,0	21,5	19,6	17,2	14,1		
	2,2	90L	0,69	0,96	1,15	1,26	1,40	1,50	1,55	1,70	1,74		
32-160B	2,2	90L	29,0		28,5	28,0	27,3	25,7	23,8	21,4	18,5	14,8	
			0,93		1,36	1,50	1,67	1,83	1,99	2,15	2,24	2,32	
32-160A	3	100L	36,8		36,4	36,0	35,4	34,2	32,8	31,1	28,8	26,0	22,3
	4	112M	1,36		1,87	2,05	2,25	2,50	2,70	2,90	3,10	3,25	3,39

# 32-200

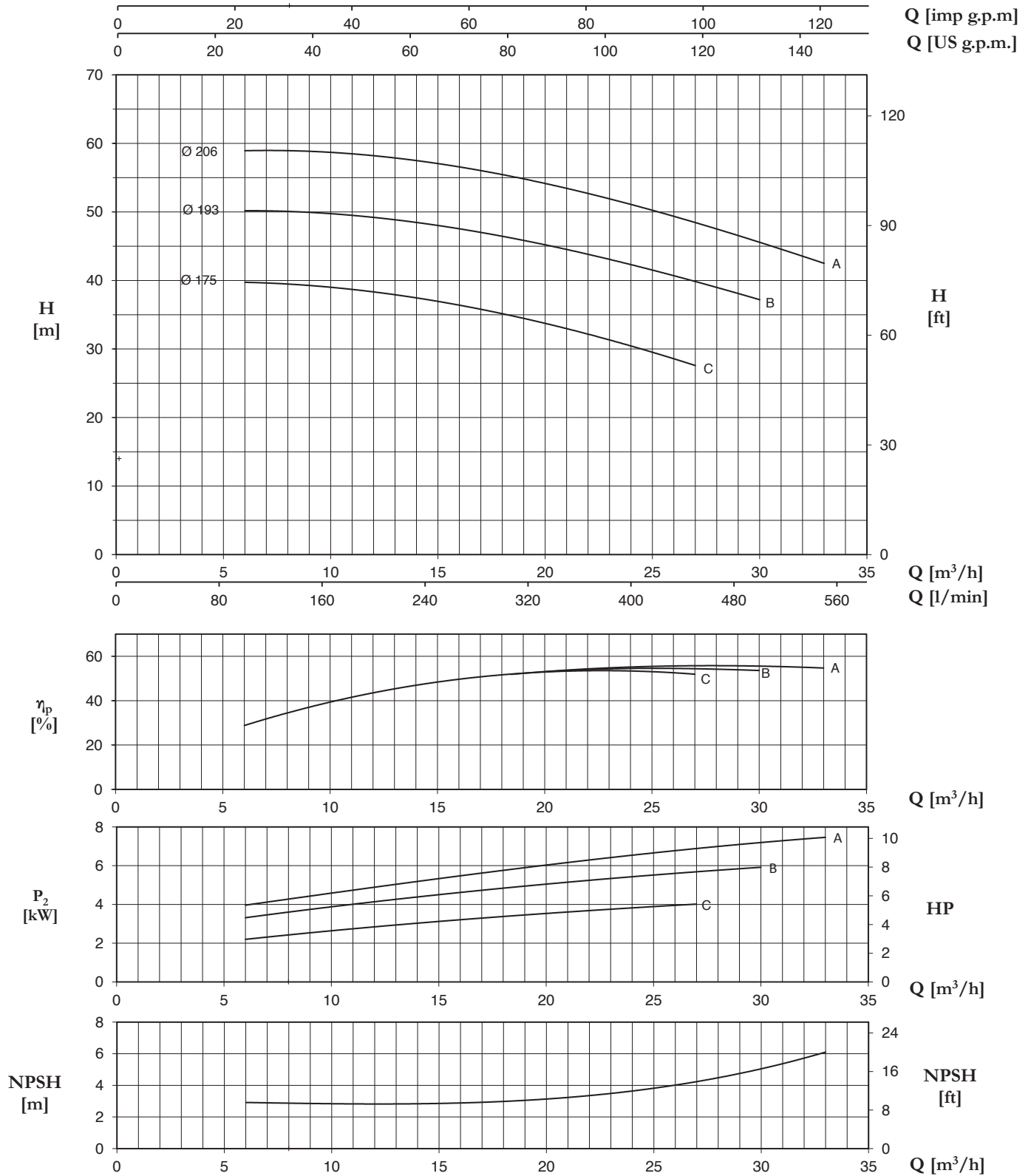

Tolerance: ISO 9906:2012 - Grade 3B

TYPE	Nominal Power (kW)	Motor Size	Q (m³/h - l/min)												
			0	6	7,5	9	12	15	18	21	24	27	30	33	
			0	100	125	150	200	250	300	350	400	450	500	550	
			H (m) / pump input power (kW)												
<b>32-200C</b>	4	112M	40,1 1,57	39,7 2,2	39,6 1,57	39,3 2,53	38,3 2,84	36,9 3,13	35,2 3,38	33,0 3,61	30,4 3,82	27,6 4,02			
<b>32-200B</b>	5,5 7,5	132S 132S	50,1 2,17	50,2 2,95	50,1 3,18	49,9 3,38	49,3 3,78	48,0 4,15	46,4 4,49	44,5 4,78	42,4 5,07	39,8 5,38	37,2 5,64		
<b>32-200A</b>	7,5	132S	58,6 2,63	59,0 3,53	58,9 3,77	58,8 4,02	58,2 4,49	57,1 4,92	55,5 5,30	53,4 5,66	51,1 6,03	48,4 6,40	45,6 6,68	42,5 6,95	

# 32-250

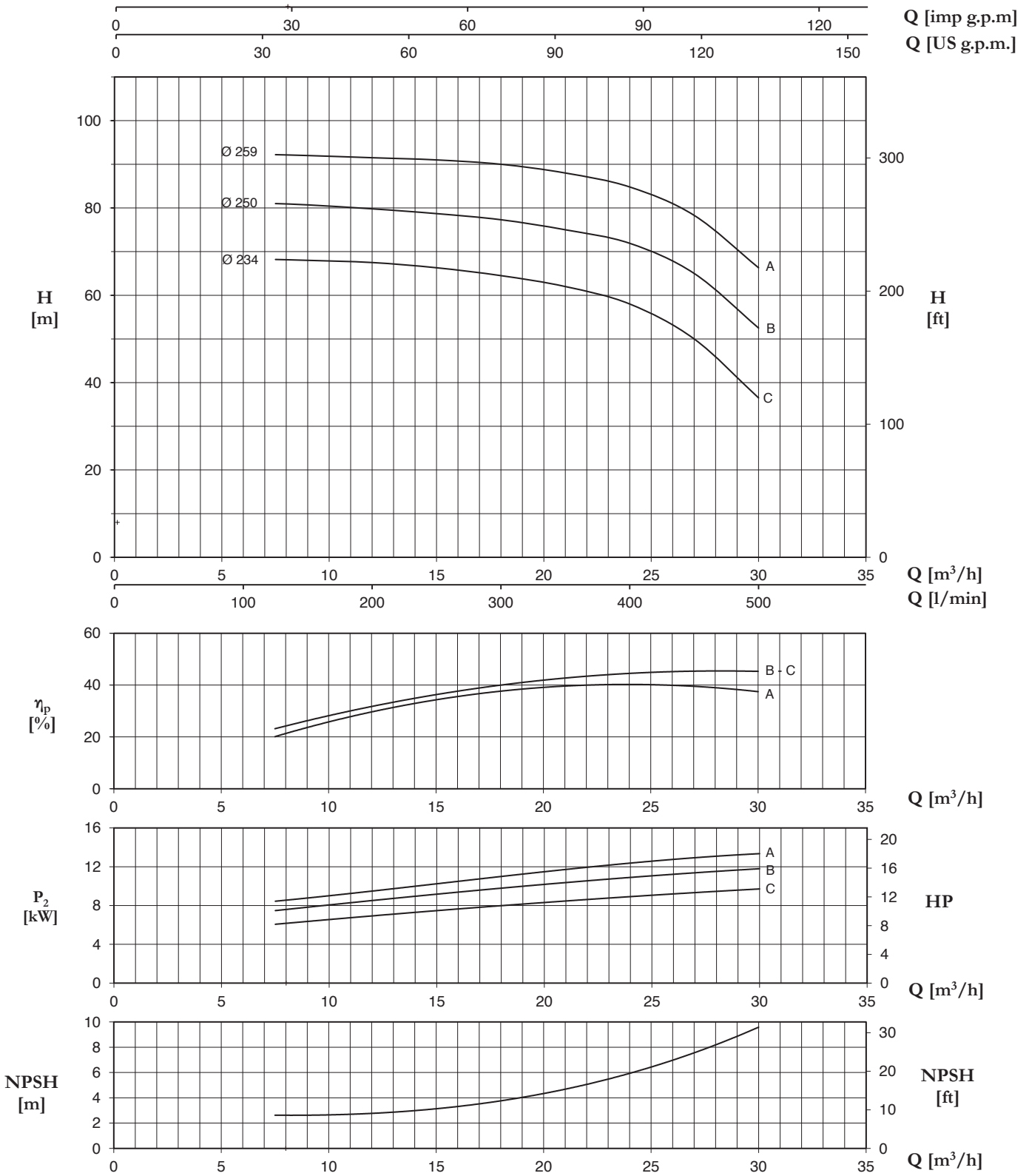

Tolerance: ISO 9906:2012 - Grade 3B

TYPE	Nominal Power (kW)	Motor Size	Q (m³/h - l/min)											
			0	7,5	9	12	15	18	21	24	27	30		
			0	125	150	200	250	300	350	400	450	500		
H (m) / pump input power (kW)														
32-250C	11	160M	70,0	68,5	68,0	67,0	65,5	63,5	61	58	50	36,5		
			4,89	6,15	6,48	7,11	7,74	8,19	8,54	8,89	9,24	9,63		
32-250B	11	160M	82,0	81,0	80,5	79,5	78,5	77,0	74,5	71,9	65	52,5		
	15	160M	6,45	8,02	8,35	9,00	9,56	10,1	10,5	11,2	11,8	12,1		
32-250A	15	160M	93,0	92,5	92,0	91,5	90,5	89,5	87,5	85	78,5	66		
			7,85	9,30	9,88	10,7	11,4	12,2	12,9	13,6	14,3	14,9		

# 40-125

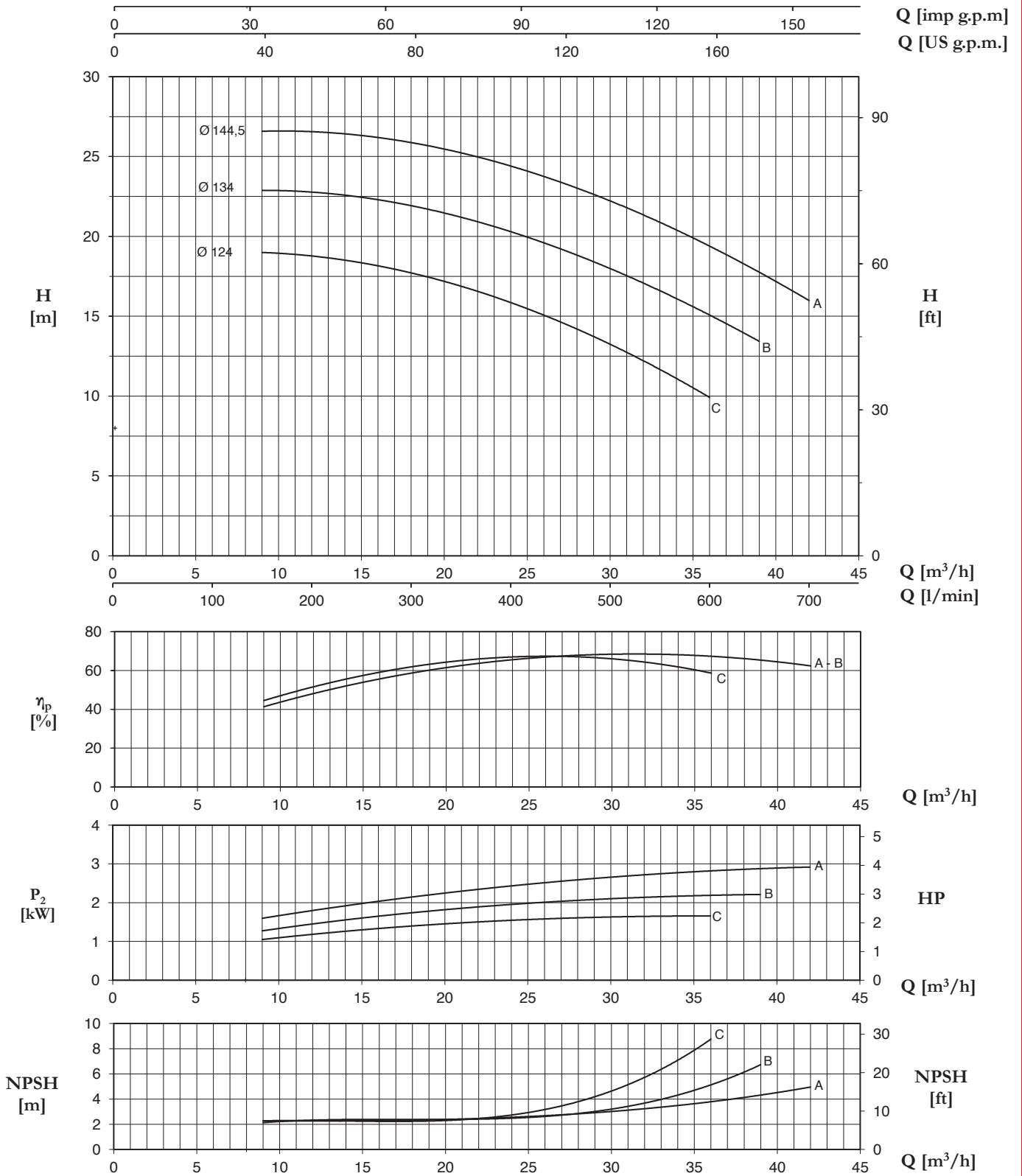

Tolerance: ISO 9906:2012 - Grade 3B

TYPE	Nominal Power (kW)	Motor Size	Q (m³/h - l/min)										
			0	9	15	21	27	30	33	36	39	42	
			0	150	250	350	450	500	550	600	650	700	
H (m) / pump input power (kW)													
40-125C	1,5	90S	18,9 0,69	19,0 1,05	18,3 1,30	16,9 1,48	14,7 1,60	13,2 1,63	11,6 1,65	9,9 1,66			
40-125B	2,2	90L	22,5 0,86	22,9 1,28	22,5 1,60	21,2 1,86	19,2 2,04	18,0 2,10	16,7 2,15	15,2 2,19	13,4 2,22		
40-125A	3	100L	26,2 1,11	26,6 1,60	26,3 1,98	25,2 2,30	23,4 2,55	22,2 2,66	20,9 2,75	19,4 2,82	17,8 2,87	16,0 2,92	

**CA/CAT - CAX/CATX EN 733 ~ 2900 r.p.m.**

**40-160**

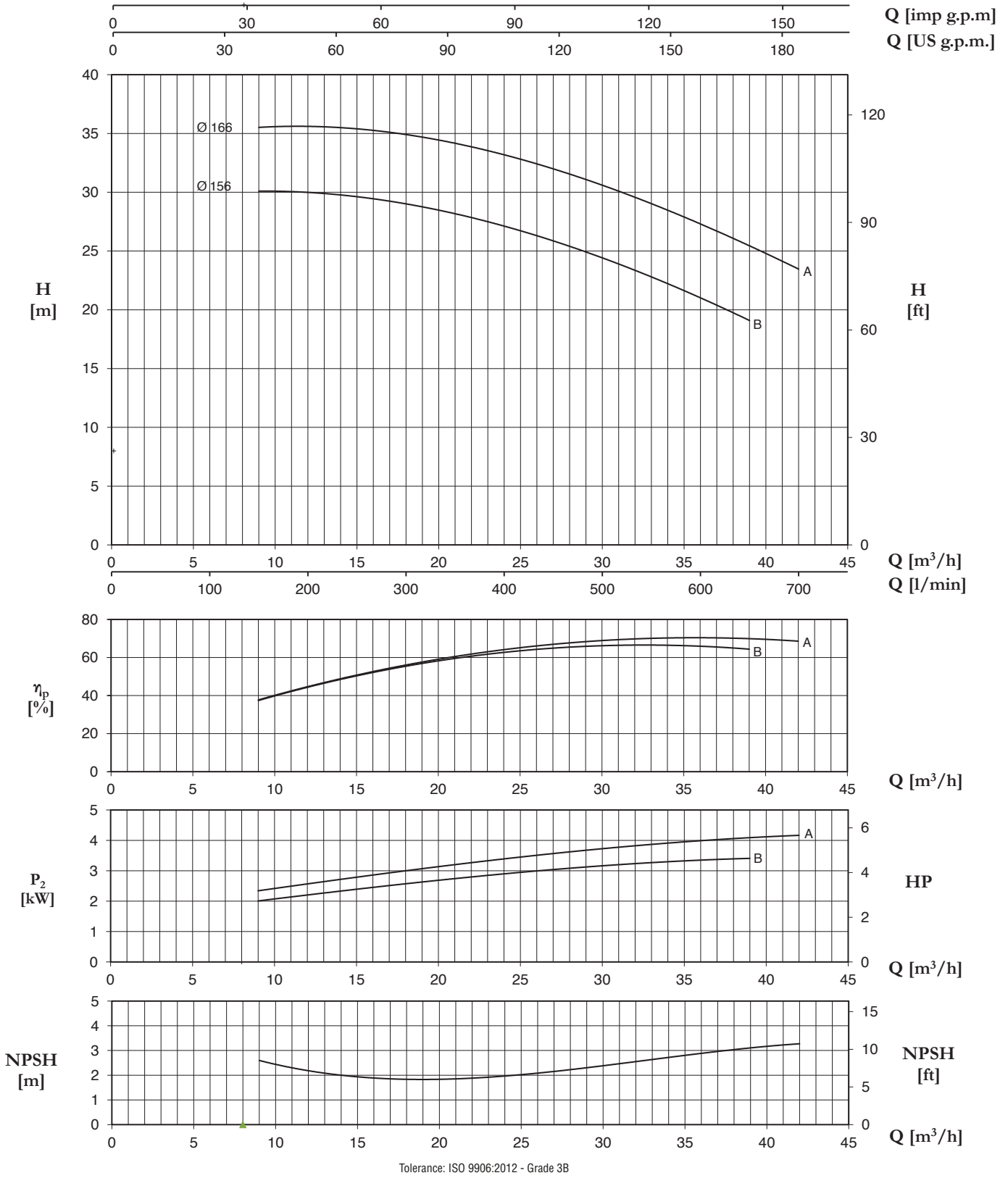

Tolerance: ISO 9906:2012 - Grade 3B

TYPE	Nominal Power (kW)	Motor Size	Q (m³/h - l/min)													
			0	9	12	15	18	21	24	27	30	33	36	39	42	
			0	150	200	250	300	350	400	450	500	550	600	650	700	
H (m) / pump input power (kW)																
40-160B	3	100L	30,0	30,1	30,0	29,6	29,0	28,2	27,1	25,9	24,4	22,8	21,0	19,1		
	4	112M	1,39	2,00	2,20	2,38	2,57	2,75	2,91	3,04	3,16	3,26	3,35	3,41		
40-160A	4	112M	35,4	35,6	35,5	35,3	35,0	34,2	33,2	32,0	30,6	29,0	27,3	25,4	23,5	
	5,5	132S	1,64	2,36	2,55	2,78	3,00	3,21	3,40	3,56	3,72	3,86	3,99	4,08	4,17	

# 40-200

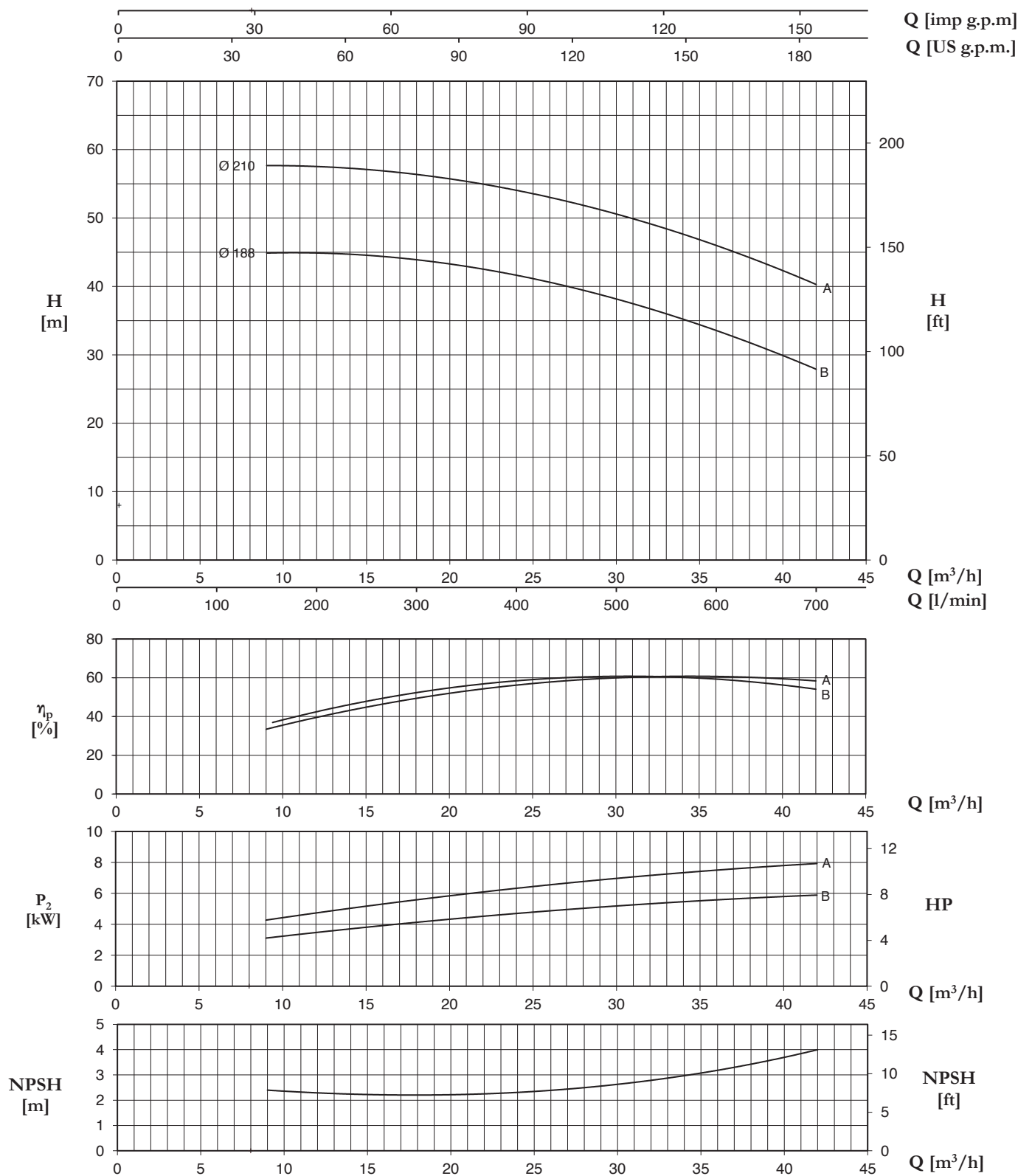

Tolerance: ISO 9906:2012 - Grade 3B

TYPE	Nominal Power (kW)	Motor Size	Q (m³/h - l/min)													
			0	9	12	15	18	21	24	27	30	33	36	39	42	
			0	150	200	250	300	350	400	450	500	550	600	650	700	
H (m) / pump input power (kW)																
40-200B	5,5	132S	44,7 2,3	44,9 3,3	44,8 3,6	44,6 3,8	44,0 4,2	42,9 4,6	41,6 4,6	40,0 5,0	38,1 5,3	36,1 5,4	33,6 5,6	30,8 5,7	27,9 6,0	
40-200A	7,5	132S	57,7 3,2	57,7 4,3	57,5 4,6	57,1 5,2	56,3 5,6	55,4 6,1	54,1 6,4	52,5 6,7	50,5 7,1	48,5 7,4	45,9 7,6	43,3 7,9	40,3 8,0	

**CA/CAT - CAX/CATX EN 733 ~ 2900 r.p.m.**

**40-250**

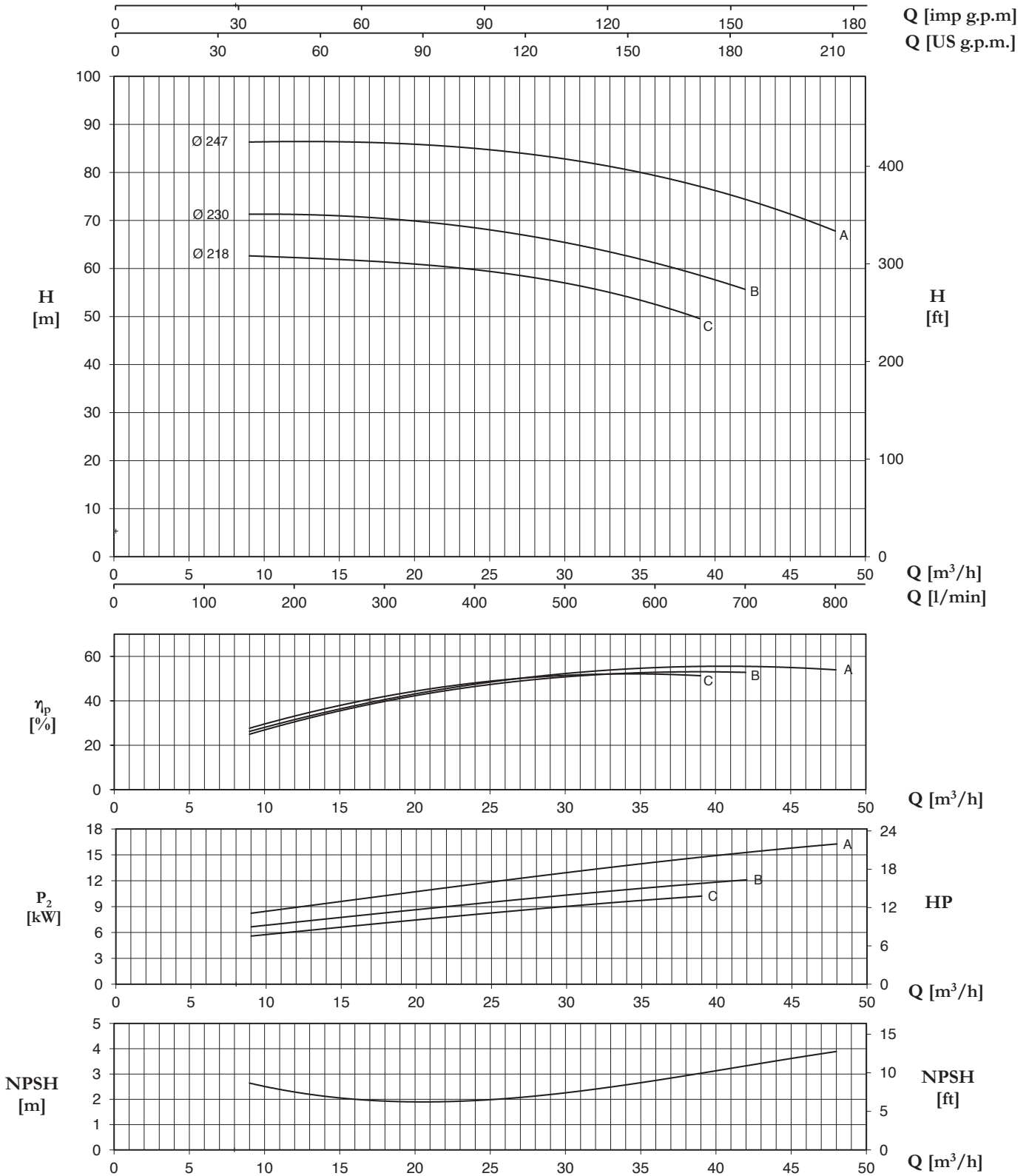

Tolerance: ISO 9906:2012 - Grade 3B

TYPE	Nominal Power (kW)	Motor Size	Q (m³/h - l/min)														
			0	9	12	15	18	21	24	27	30	33	36	39	42	48	
			0	150	200	250	300	350	400	450	500	550	600	650	700	800	
			H (m) / pump input power (kW)														
40-250C	11	160M	63,0	62,6	62,4	61,9	61,3	60,5	59,7	58,6	57,1	55,0	52,4	49,6			
			4,40	5,60	6,08	6,61	7,13	7,63	8,10	8,57	9,04	9,45	9,83	10,22			
40-250B	11	160M	70,8	71,3	71,2	71,0	70,5	69,8	68,4	66,6	65,4	63,8	61,2	58,5	55,6		
		160M	5,16	6,65	7,22	7,76	8,28	8,80	9,33	9,86	10,35	10,82	11,25	11,69	12,11		
40-250A	15	160M	86,1	86,3	86,5	86,4	86,0	85,6	85,0	84,1	82,9	81,3	79,4	77,0	74,3	67,9	
		160L	6,70	8,24	8,89	9,58	10,29	10,97	11,65	12,31	12,95	13,55	14,13	14,74	15,32	16,27	

# 50-125

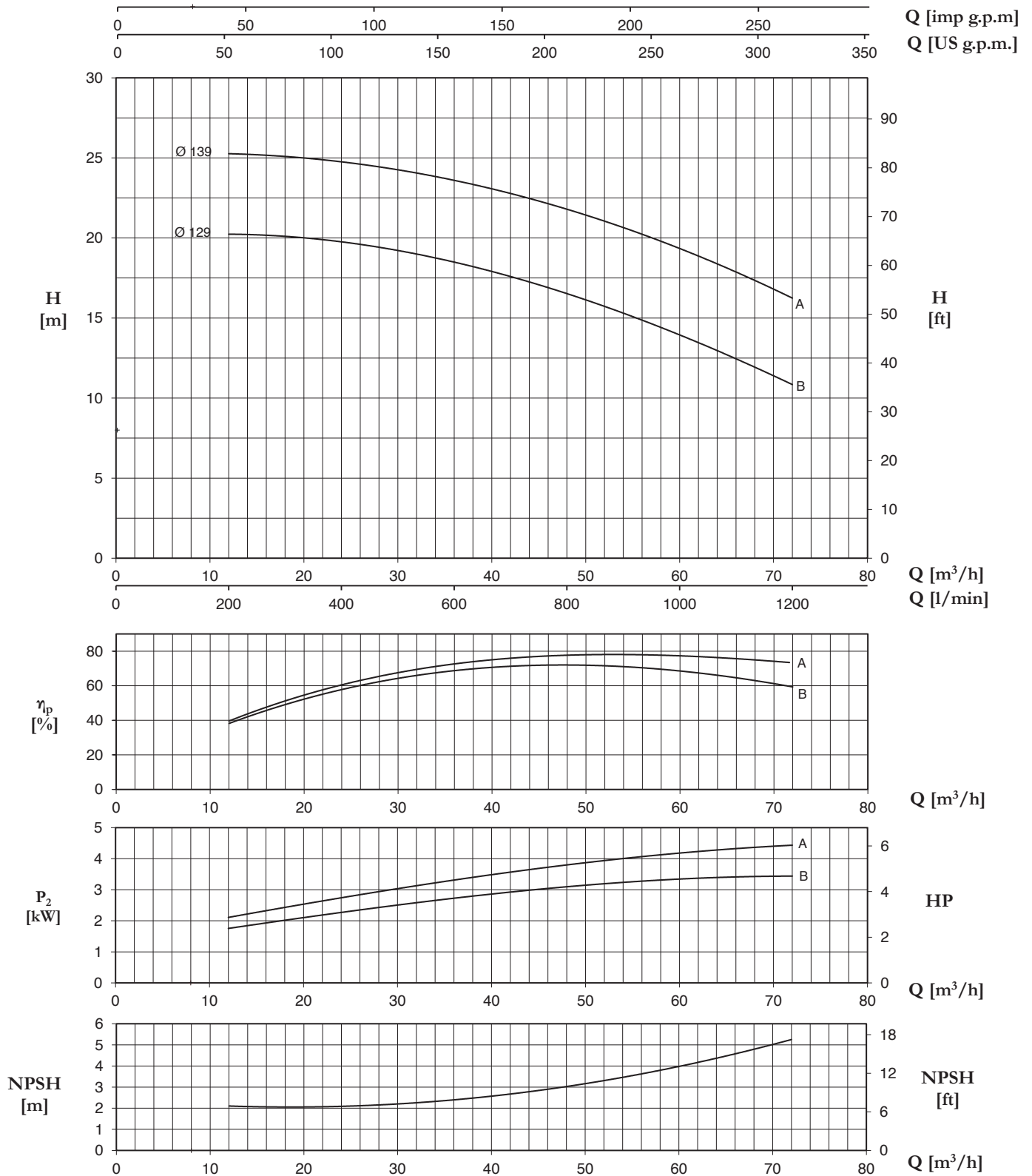

Tolerance: ISO 9906:2012 - Grade 3B

TYPE	Nominal Power (kW)	Motor Size	Q (m³/h - l/min)																
			0	12	15	18	21	24	27	30	33	36	39	42	48	54	60	66	72
			0	200	250	300	350	400	450	500	550	600	650	700	800	900	1000	1100	1200
H (m) / pump input power (kW)																			
50-125B	3	100L	19,9	20,2	20,2	20,1	20,0	19,8	19,3	19,1	18,7	18,3	17,8	17,4	16,4	15,3	14,0	12,7	
	4	112M	1,22	1,77	1,94	2,11	2,22	2,33	2,44	2,55	2,65	2,76	2,87	2,98	3,10	3,20	3,30	3,39	3,43
50-125A	4	112M	24,5		25,0	24,9	24,8	24,6	24,4	24,2	23,8	23,5	23,1	22,7	21,8	20,8	19,6	18,1	16,5
	5,5	132S	1,78		2,54	2,70	2,85	3,01	3,17	3,33	3,42	3,50	3,59	3,67	4,14	4,42	4,58	4,74	4,90

**CA/CAT - CAX/CATX EN 733 ~ 2900 r.p.m.**

**50-160**

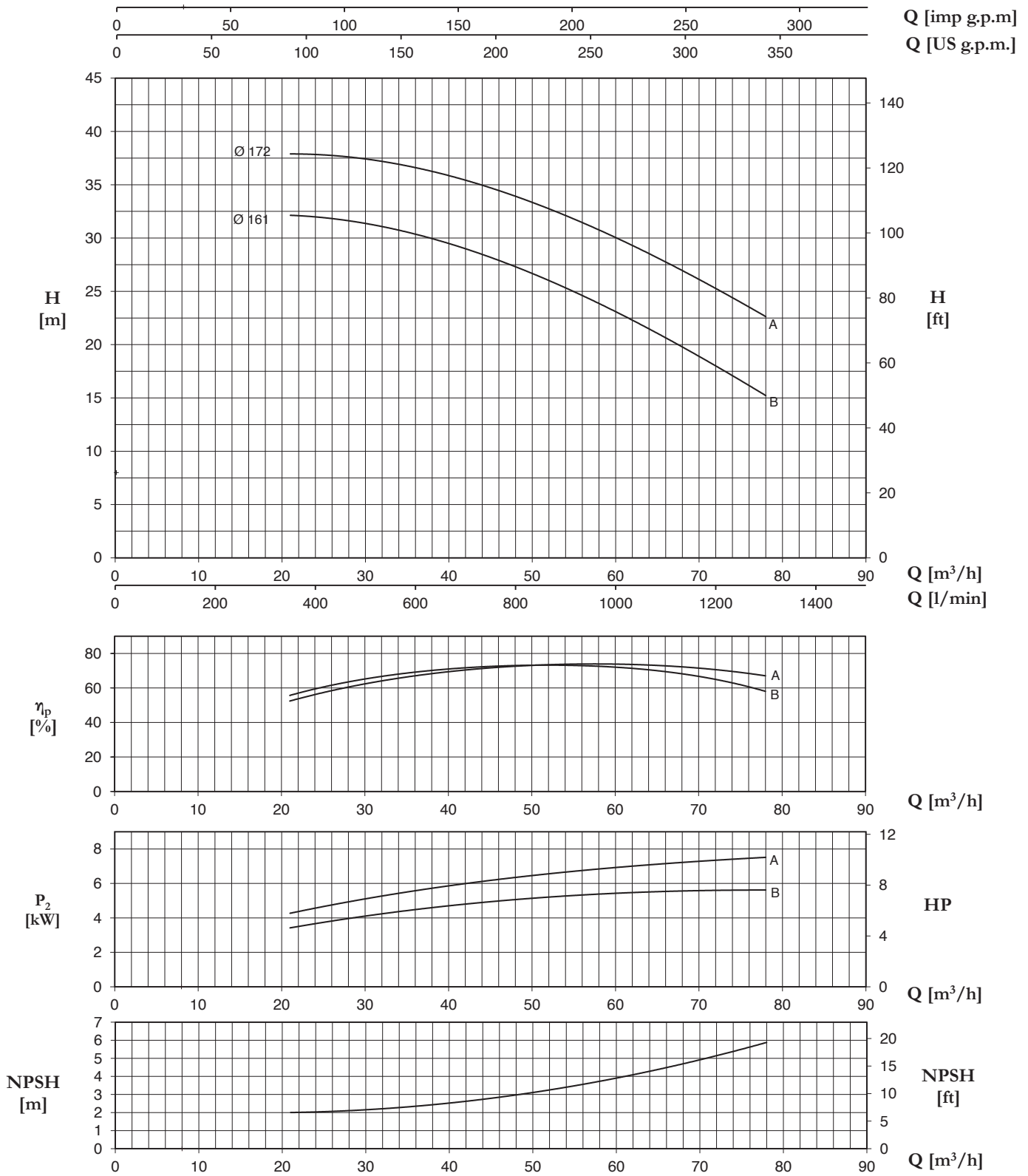

Tolerance: ISO 9906:2012 - Grade 3B

TYPE	Nominal Power (kW)	Motor Size	Q (m³/h - l/min)															
			0	21	24	27	30	33	36	39	42	48	54	60	66	72	78	
			0	350	400	450	500	550	600	650	700	800	900	1000	1100	1200	1300	
H (m) / pump input power (kW)																		
50-160B	5,5	132S	31,1 2,1	32,1 3,6	32,0 3,8	31,7 4,0	31,4 4,2	31,0 4,4	30,4 4,6	29,7 4,7	28,9 4,9	27,3 4,9	25,3 5,4	23,1 5,5	20,7 5,5	18,0 5,6	15,2 5,7	
50-160A	7,5	132S	36,7 2,6	37,9 4,2	37,8 4,5	37,7 4,9	37,4 5,1	37,1 5,4	36,6 5,6	36,1 5,9	35,4 6,2	33,9 6,5	32,1 6,9	30,0 7,1	27,8 7,3	25,3 7,5	22,6 7,6	

# 50-200

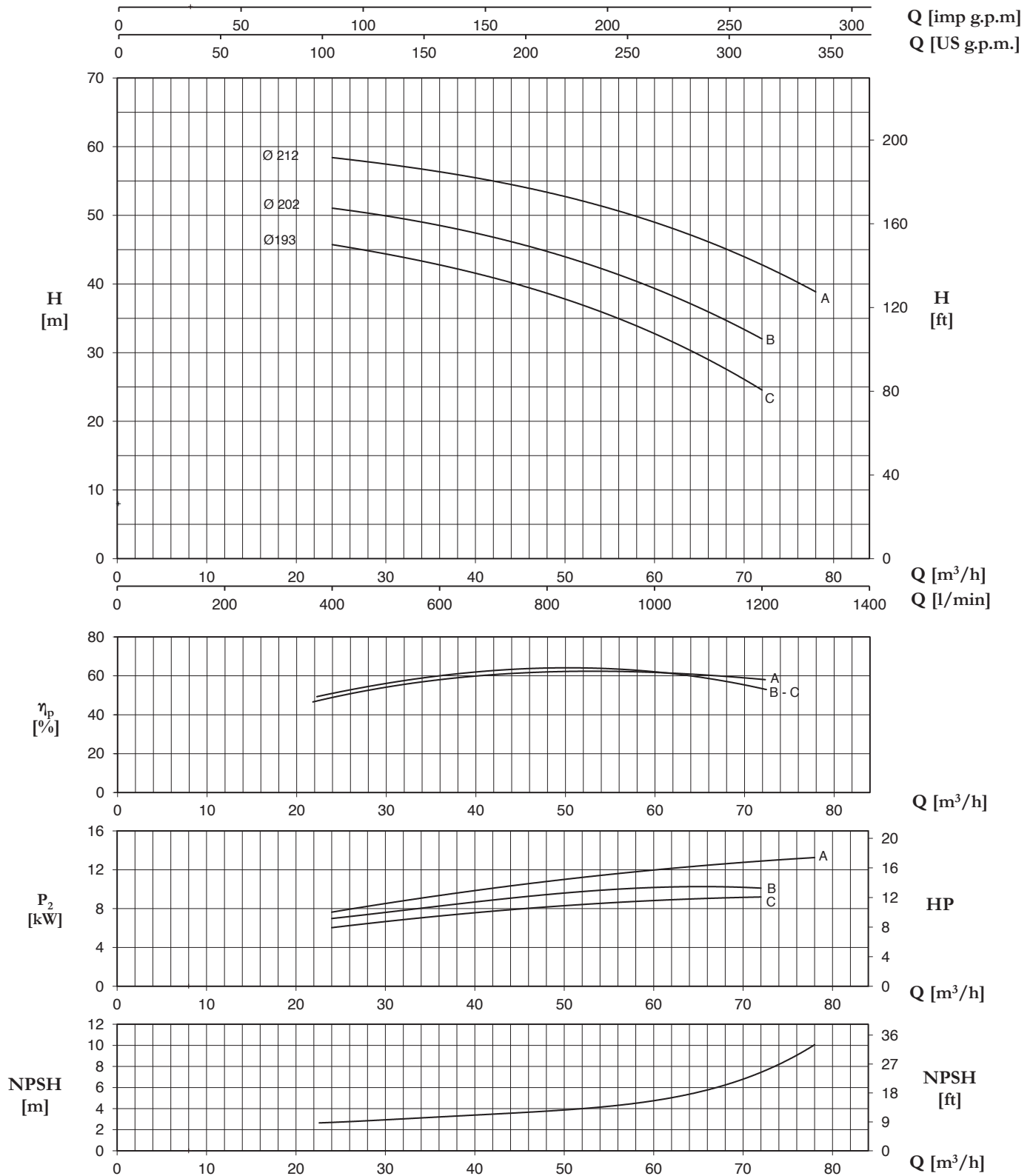

Tolerance: ISO 9906:2012 - Grade 3B

TYPE	Nominal Power (kW)	Motor Size	Q (m³/h - l/min)													
			0	24	27	30	33	36	39	42	48	54	60	66	72	78
			0	400	450	500	550	600	650	700	800	900	1000	1100	1200	1300
H (m) / pump input power (kW)																
50-200C	11	160M	46,0 3,25	45,6 6,08	45,1 6,30	44,5 6,53	43,7 6,76	42,9 7,11	41,8 7,46	40,8 7,82	38,5 8,17	35,9 8,33	33,0 8,50	29,0 8,78	24,5 9,06	
50-200B	11	160M	50,8 3,38	51,0 6,68	50,5 7,53	50,0 7,80	49,3 8,20	48,5 8,46	47,7 8,81	46,8 9,15	44,7 9,50	42,2 9,85	39,5 10,1	35,9 10,4	32,0 10,6	
50-200A	15	160M	58,0 4,63	58,3 7,89	58,0 8,28	57,5 8,67	57,0 9,08	56,4 9,49	55,7 9,89	55,0 10,3	53,2 10,7	51,3 11,3	49,0 11,9	46,3 12,3	42,8 12,7	38,8 13,0

**CA/CAT - CAX/CATX EN 733 ~ 2900 r.p.m.**

**50-250**

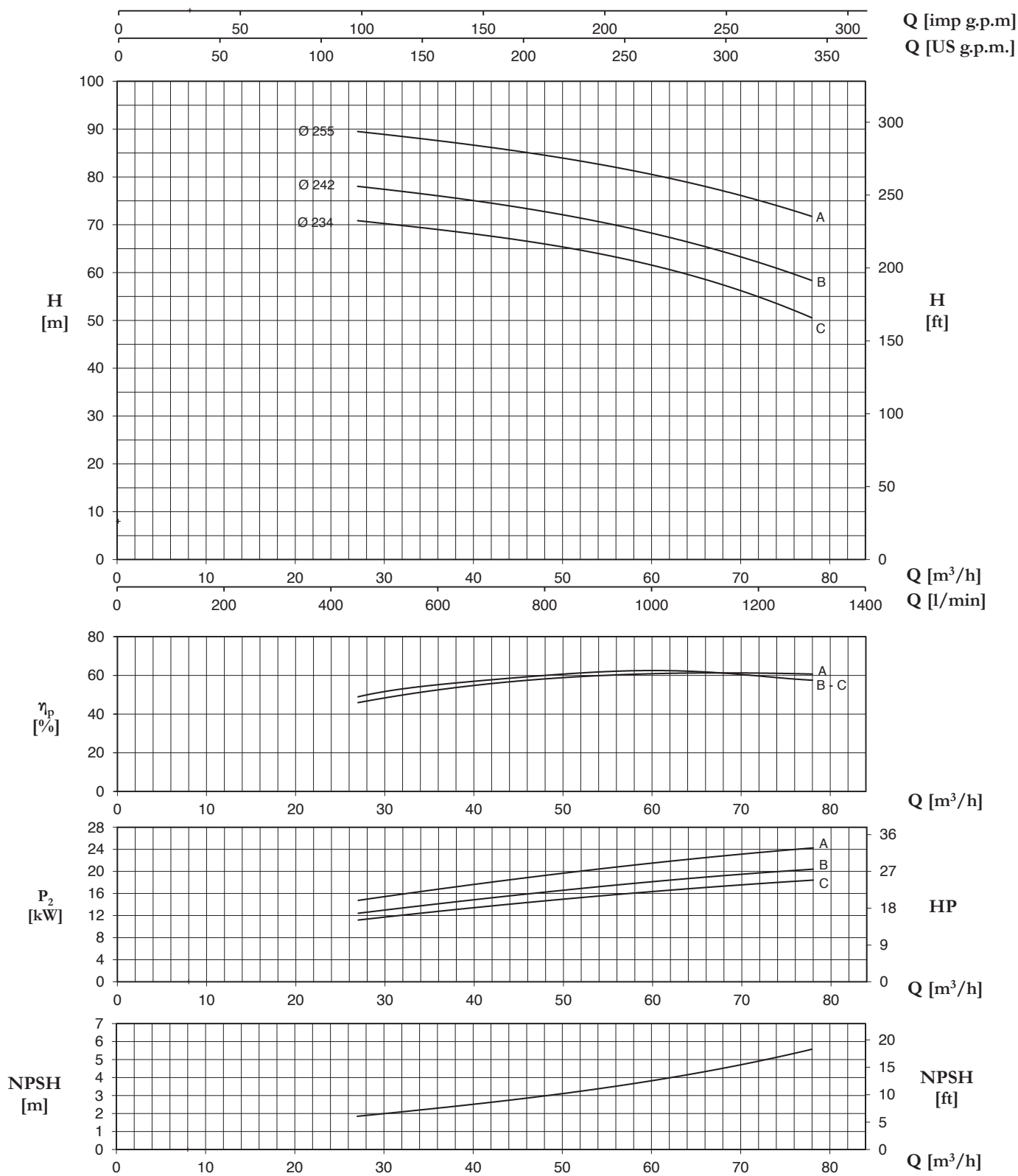

Tolerance: ISO 9906:2012 - Grade 3B

TYPE	Nominal Power (kW)	Motor Size	Q (m³/h - l/min)														
			0	27	30	33	36	39	42	48	54	60	66	72	78		
			0	450	500	550	600	650	700	800	900	1000	1100	1200	1300		
H (m) / pump input power (kW)																	
50-250C	15	160M	71,5	70,8	70,3	69,7	69,0	68,3	67,6	66,0	64,0	61,5	58,6	55,0	50,5		
	18,5	160L	6,74	11,3	11,9	12,5	12,9	13,4	13,8	14,6	15,5	16,3	17,0	17,7	18,4		
50-250B	18,5	160L	78,0	78,0	77,4	76,8	76,1	75,3	74,5	72,8	70,6	68,2	65,5	62,2	58,3		
	22	180M	6,87	12,0	12,7	13,3	14,0	14,6	15,3	15,9	16,9	17,9	18,6	19,3	20,2		
50-250A	22	180M	90,0	89,5	88,8	88,3	87,7	86,9	86,1	84,5	82,7	80,5	78,0	75,2	71,7		
	30	200L	10,1	15,6	16,3	17,0	17,6	18,2	19,2	20,1	21,1	22,0	23,0	23,9	24,8		

# 65-125

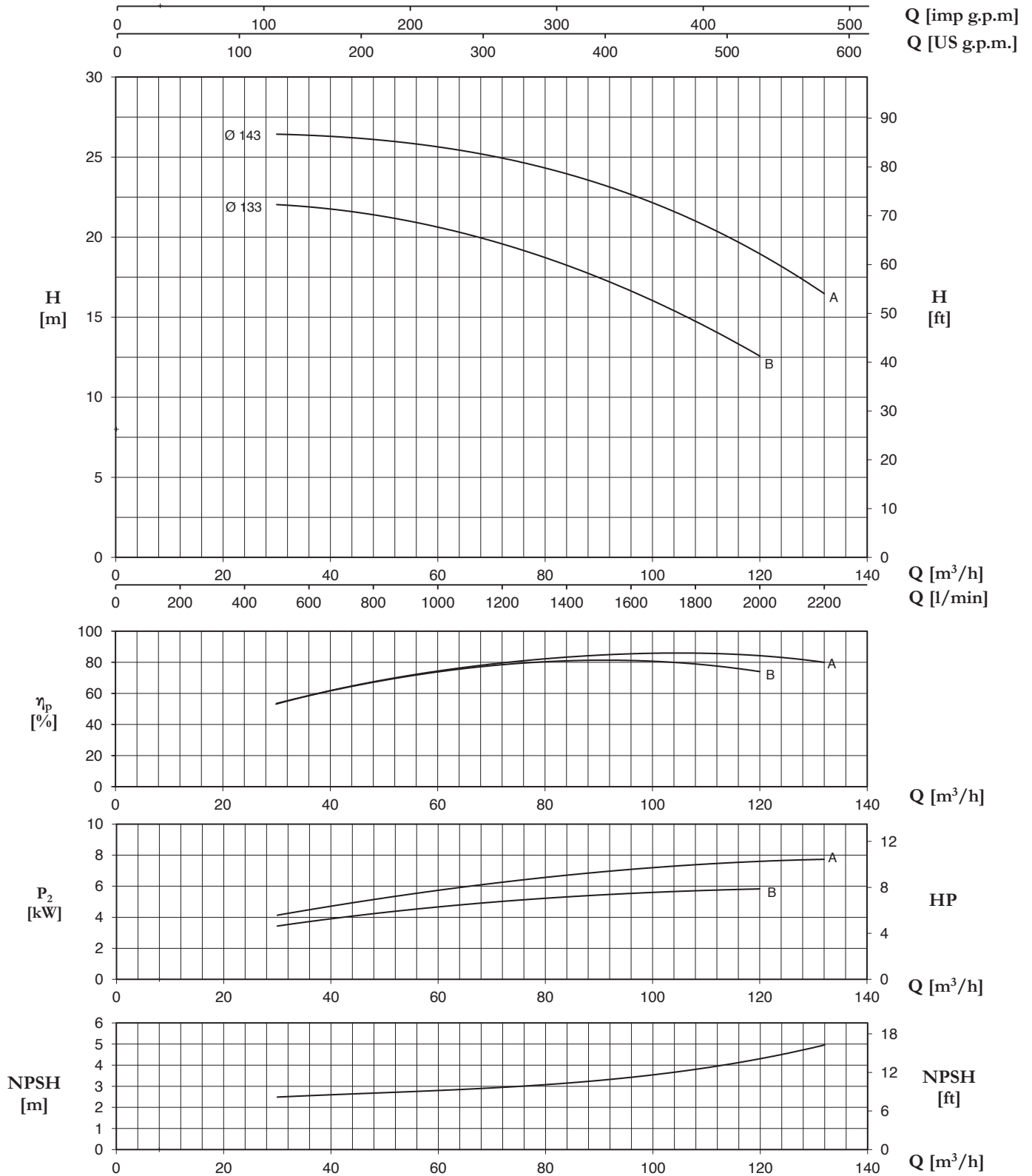

Tolerance: ISO 9906:2012 - Grade 3B

TYPE	Nominal Power (kW)	Motor Size	Q (m³/h - l/min)																
			0	30	33	36	39	42	48	54	60	66	72	78	84	96	108	120	132
			0	500	550	600	650	700	800	900	1000	1100	1200	1300	1400	1600	1800	2000	2200
			H (m) / pump input power (kW)																
65-125B	5,5	132S	20,9 2,3	22,0 3,6	22,0 3,7	21,9 3,8	21,8 3,9	21,7 4,0	21,4 4,3	21,0 4,6	20,6 4,7	20,1 5,0	19,6 5,1	19,0 5,2	18,3 5,4	16,6 5,4	14,7 5,8	12,6 5,9	
65-125A	7,5	132S	25,4 2,8	26,4 4,1	26,4 4,3	26,4 4,6	26,3 4,7	26,3 4,9	26,1 5,2	25,9 5,5	25,6 5,9	25,3 6,1	24,9 6,4	24,5 6,7	24,0 6,9	22,7 7,2	21,0 7,5	18,9 7,7	16,5 7,8

**CA/CAT - CAX/CATX EN 733 ~ 2900 r.p.m.**

**65-160**

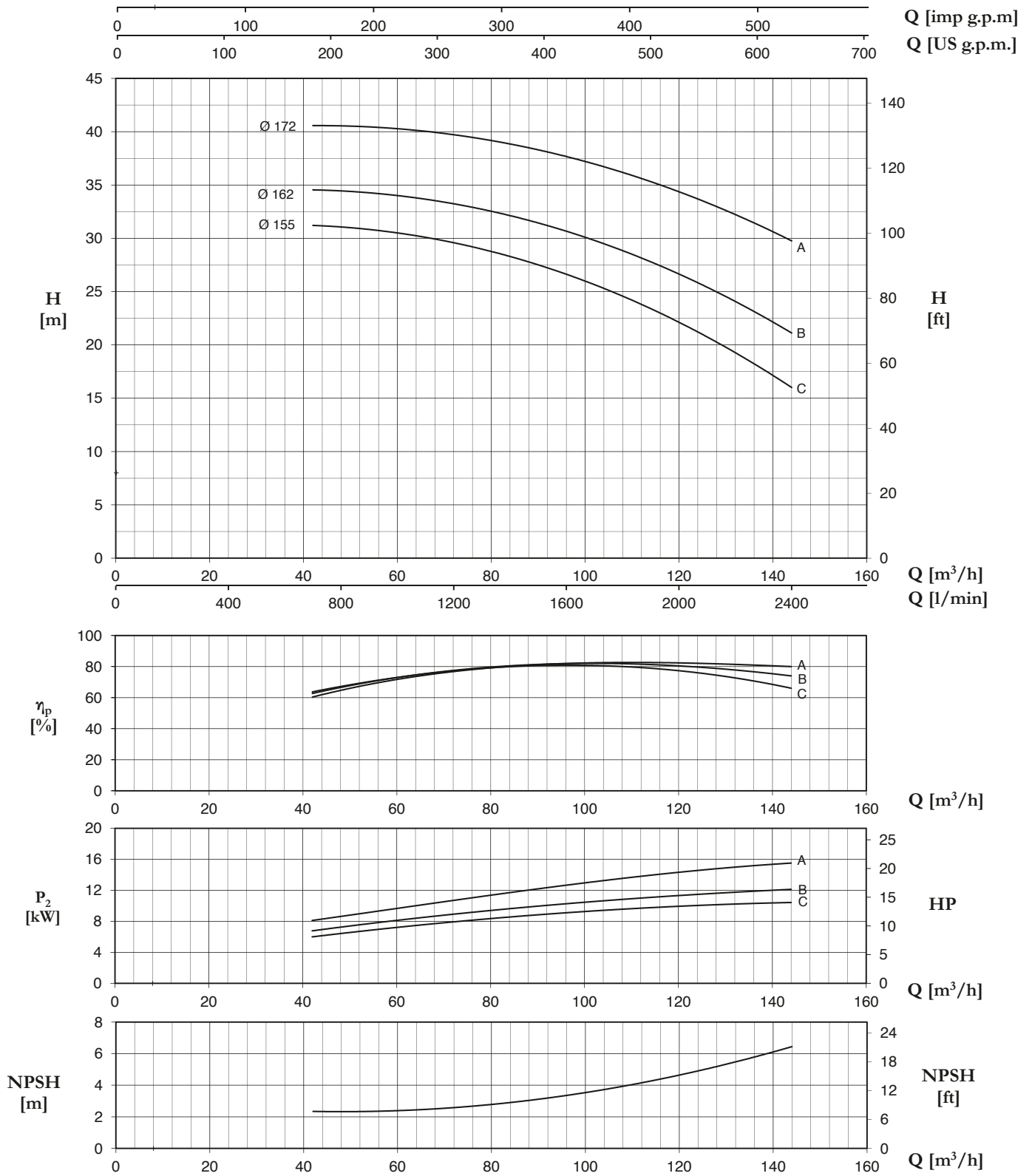

Tolerance: ISO 9906:2012 - Grade 3B

TYPE	Nominal Power (kW)	Motor Size	Q (m³/h - l/min)													
			0	42	48	54	60	66	72	78	84	96	108	120	132	144
			0	700	800	900	1000	1100	1200	1300	1400	1600	1800	2000	2200	2400
			H (m) / pump input power (kW)													
<b>65-160C</b>	11	160M	29,8 3,29	31,2 5,92	31,1 6,29	30,8 6,66	30,5 7,04	30,1 7,41	29,6 7,79	29,0 8,16	28,3 8,59	26,6 9,02	24,6 9,45	22,1 9,88	19,3 9,85	16,0 9,82
<b>65-160B</b>	11	160M	33,0 3,17	34,6 6,72	34,4 7,22	34,2 7,73	34,0 8,24	33,7 8,57	33,3 8,90	32,8 9,23	32,1 9,56	30,6 10,1	28,8 10,6	26,7 11,2	24,1 11,1	21,1 11,0
<b>65-160A</b>	15	160M	39,2 4,8	40,6 8,05	40,6 8,60	40,4 9,15	40,2 9,70	40,0 10,2	39,7 10,8	39,4 11,3	38,9 11,9	37,7 12,4	36,2 13,0	34,3 13,6	32,2 13,6	29,8 13,7

# 65-200

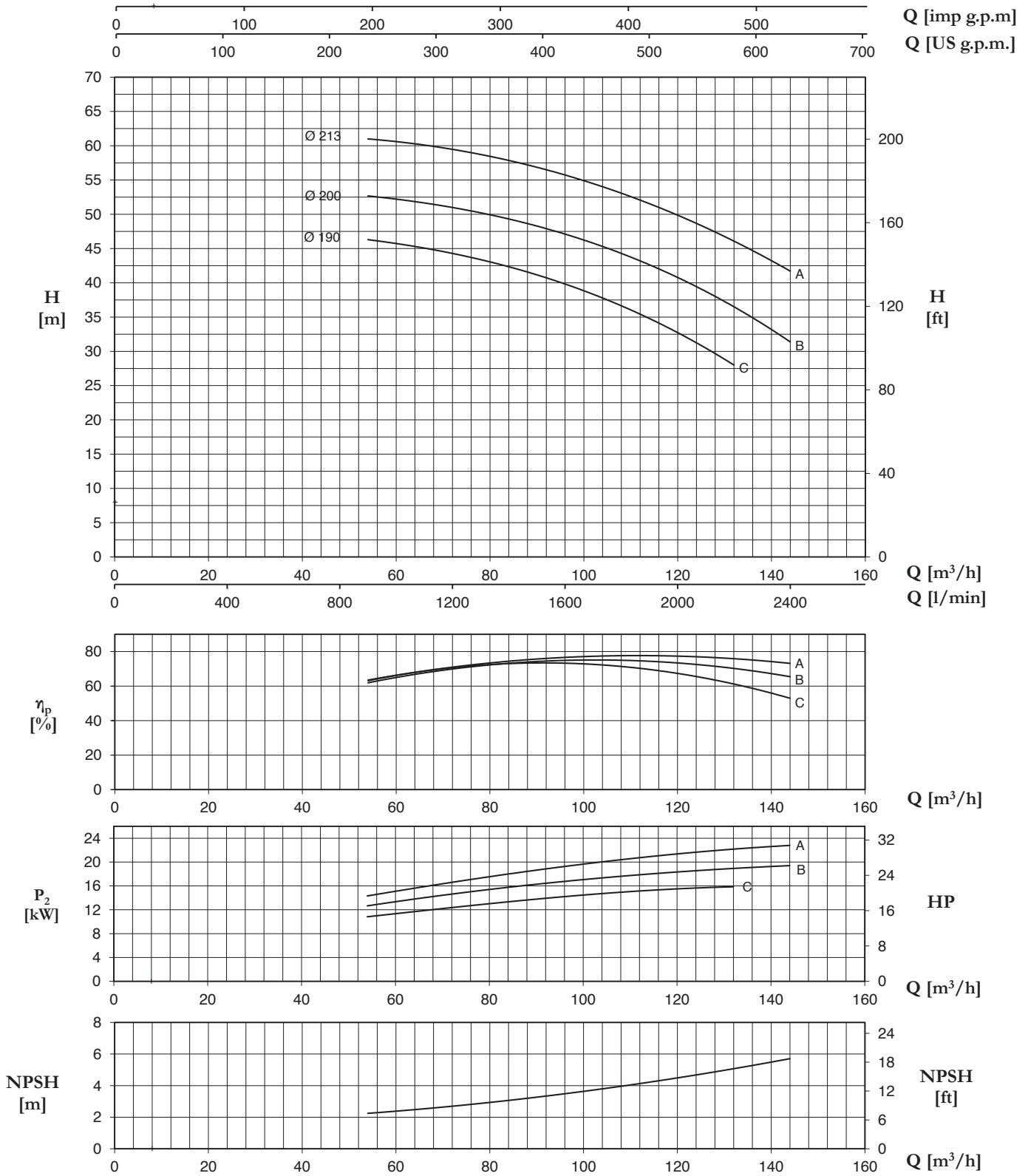

Tolerance: ISO 9906:2012 - Grade 3B

TYPE	Nominal Power (kW)	Motor Size	Q (m³/h - l/min)												
			0	54	60	66	72	78	84	96	108	120	132	144	
			0	900	1000	1100	1200	1300	1400	1600	1800	2000	2200	2400	
H (m) / pump input power (kW)															
<b>65-200C</b>	15	160M	45,3 4,9	46,3 10,8	45,7 11,3	45,1 11,8	44,3 12,3	43,4 12,9	42,3 13,3	39,8 13,8	36,7 14,9	32,7 15,4	28,0 15,8		
<b>65-200B</b>	18,5	160L	51,6 5,4	52,6 11,6	52,2 12,2	51,8 13,0	51,0 13,8	50,2 14,3	49,3 15,0	47,1 16,0	44,1 16,7	40,9 17,5	36,6 18,2	31,3 18,6	
<b>65-200A</b>	22	180M	60,2 7,6	61,0 14,9	60,6 15,4	60,1 16,2	59,5 17,1	58,7 17,9	57,8 18,8	55,8 19,8	53,1 20,9	49,8 22,0	46,1 22,8	41,7 23,3	

**CA/CAT - CAX/CATX EN 733 ~ 2900 r.p.m.**

**65-250**

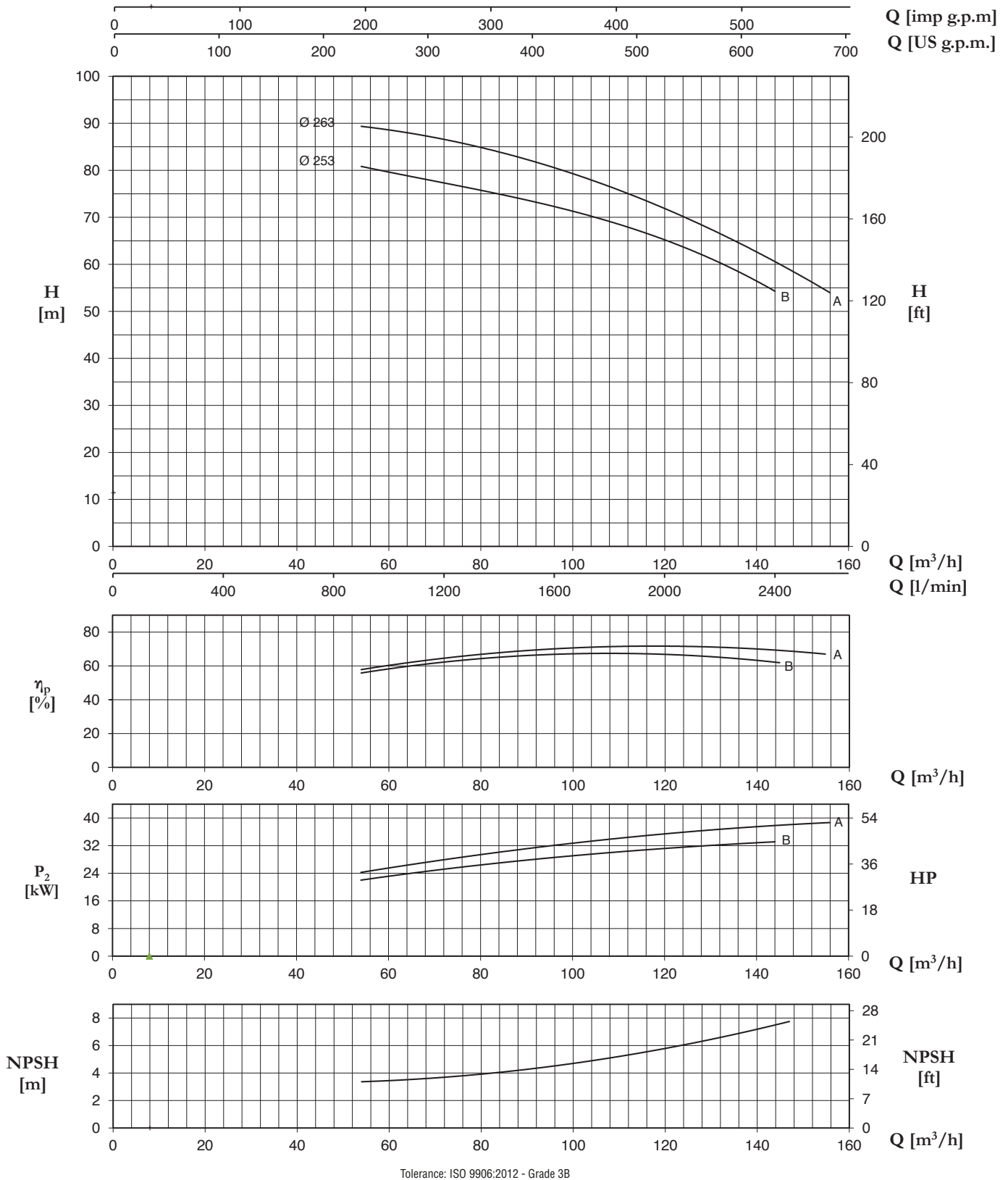

TYPE	Nominal Power (kW)	Motor Size	Q (m³/h - l/min)													
			0	54	60	66	72	78	84	96	108	120	132	144	156	
			0	900	1000	1100	1200	1300	1400	1600	1800	2000	2200	2400	2600	
H (m) / pump input power (kW)																
65-250B	30	200L	81,0	79,5	78,5	77,3	76,0	74,5	73,0	69,3	65,0	60,0	54,5	48,5		
			10,6	20,9	22,4	23,3	24,3	25,2	26,3	27,5	28,7	29,8	30,7	31,5		
65-250A	37	200L	90,0	89,5	88,5	87,5	86,5	85,5	84,0	80,5	76,5	72,0	66,5	60,5	54,0	
			12,3	23,7	25,7	26,7	27,8	28,9	29,9	31,7	33,6	35,4	36,1	36,9	37,6	

# 80-160

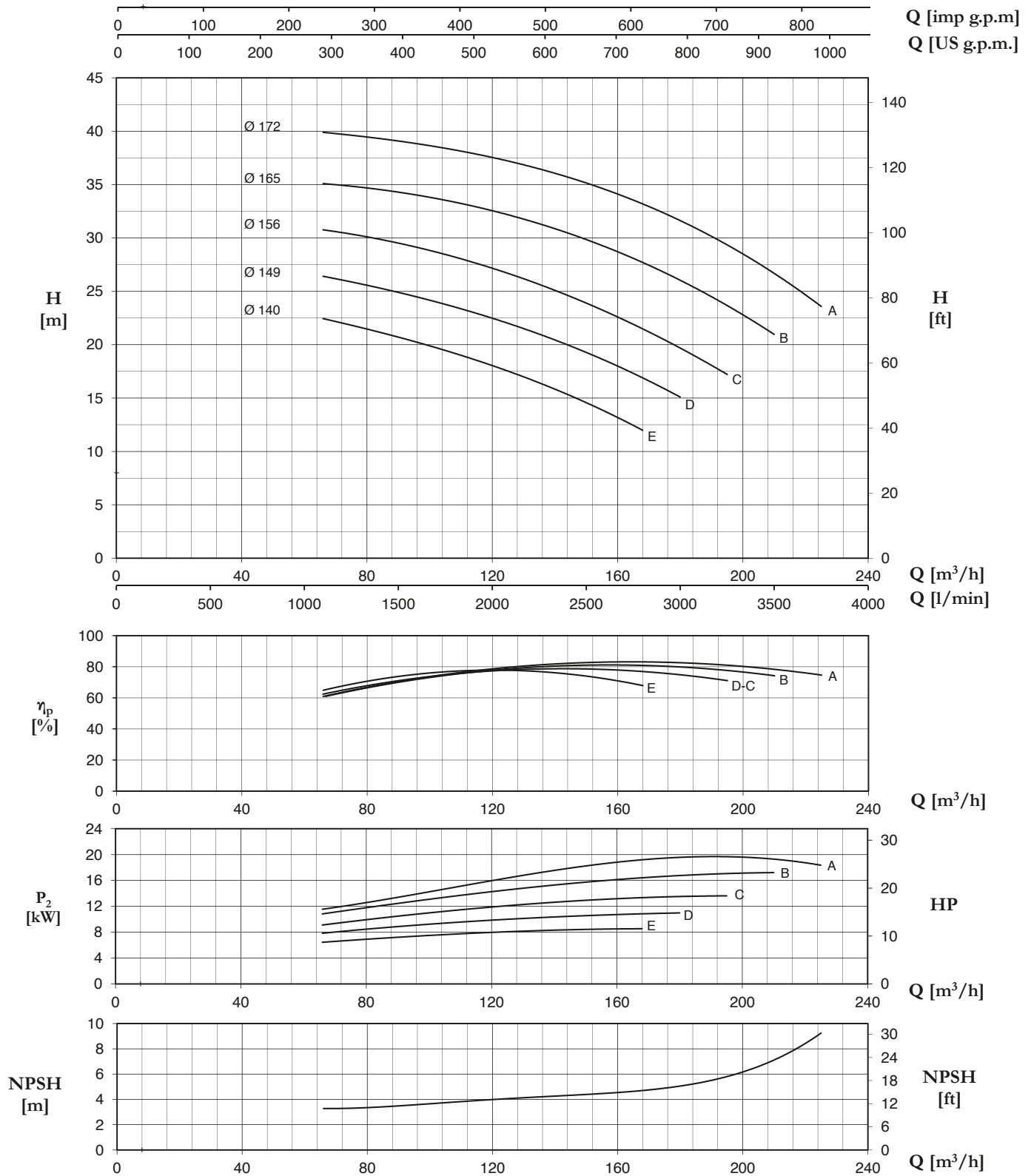

Tolerance: ISO 9906:2012 - Grade 3B

TYPE	Nominal Power (kW)	Motor Size	Q (m³/h - l/min)												
			0	78	96	108	120	144	168	180	195	210	225		
			0	1300	1600	1800	2000	2400	2800	3000	3250	3500	3750		
H (m) / pump input power (kW)															
80-160E	11	160M	21,4 3,6	21,6 6,8	20,2 7,3	19,2 7,6	18,0 8,0	15,4 8,4	12,0 8,4						
80-160D	11	160M	25,4 4,0	25,7 8,5	24,4 9,1	23,6 9,5	22,5 9,9	20,0 10,5	16,9 10,9	15,1 10,9					
80-160C	15	160M	29,7 5,2	30,3 9,7	29,2 10,7	28,1 11,1	27,1 11,7	24,7 12,7	21,5 13,3	19,7 13,5	17,2 13,5				
80-160B	18,5	160L	34,0 5,7	34,8 10,8	34,0 11,6	33,3 12,6	32,5 13,3	30,5 14,6	27,8 15,4	26,0 15,8	23,6 16,0	21,0 16,3			
80-160A	22	180M	38,8 7,3	39,6 13,3	38,9 14,6	38,2 15,6	37,5 16,5	35,7 18,0	33,2 19,3	31,6 19,8	29,4 20,3	26,8 21,0	23,5 20,1		

**CA/CAT - CAX/CATX EN 733 ~ 2900 r.p.m.**

**80-200**

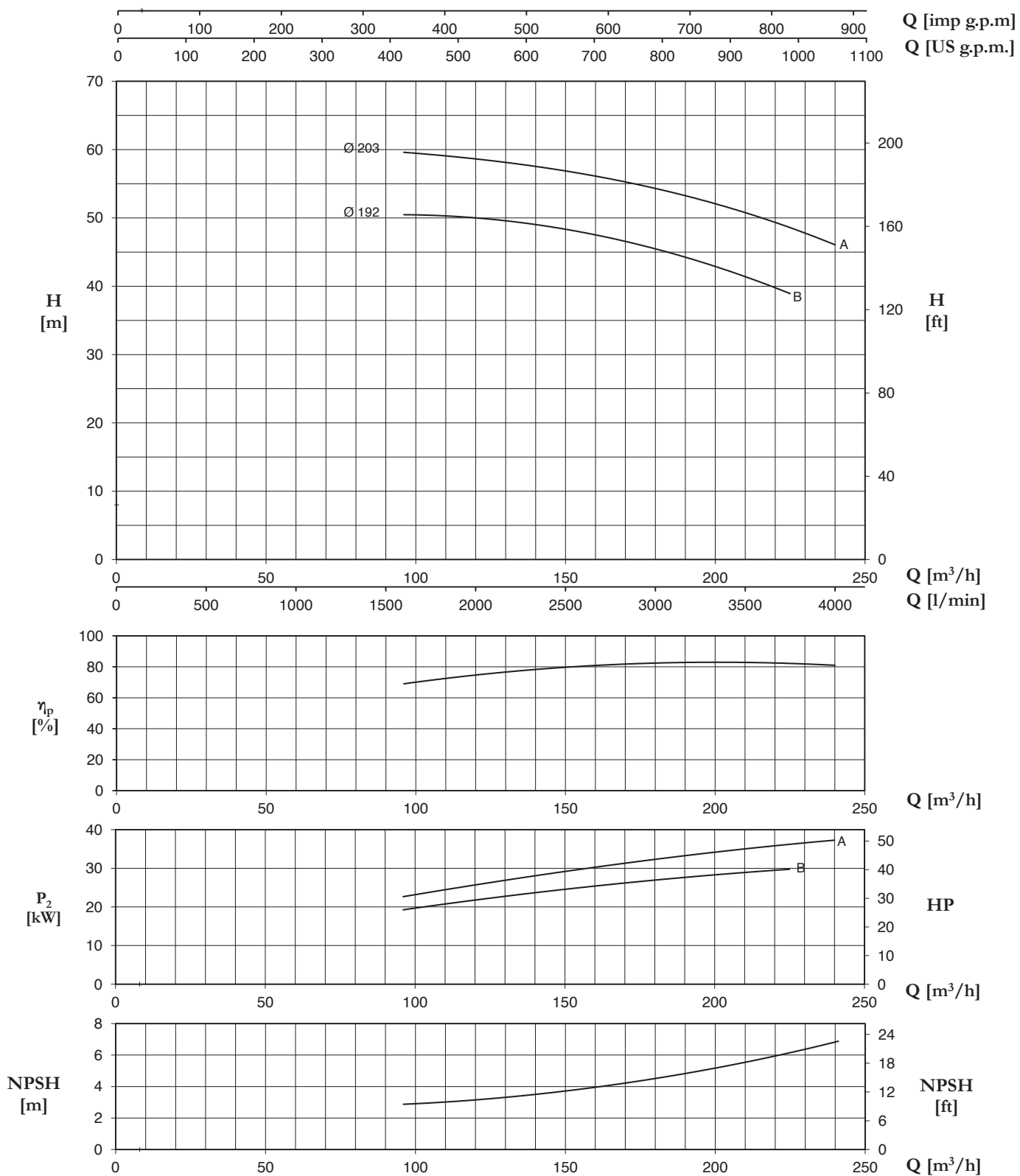

Tolerance: ISO 9906:2012 - Grade 3B

TYPE	Nominal Power (kW)	Motor Size	Q (m³/h - l/min)												
			0	96	108	120	144	168	180	195	210	225	240		
			0	1600	1800	2000	2400	2800	3000	3250	3500	3750	4000		
H (m) / pump input power (kW)															
80-200B	30	200L	49,0	50,6	50,3	49,8	48,6	46,7	45,5	44,8	41,6	38,6			
			9,3	20,0	21,3	22,6	25,2	27,5	28,5	29,6	30,6	31,3			
80-200A	37	200L	58,0	59,6	59,2	58,6	57,3	55,5	54,3	52,7	50,8	48,5	46,1		
			11,7	24,4	25,8	27,2	30,0	33,0	34,5	35,9	37,4	38,3	39,2		

# 80-250

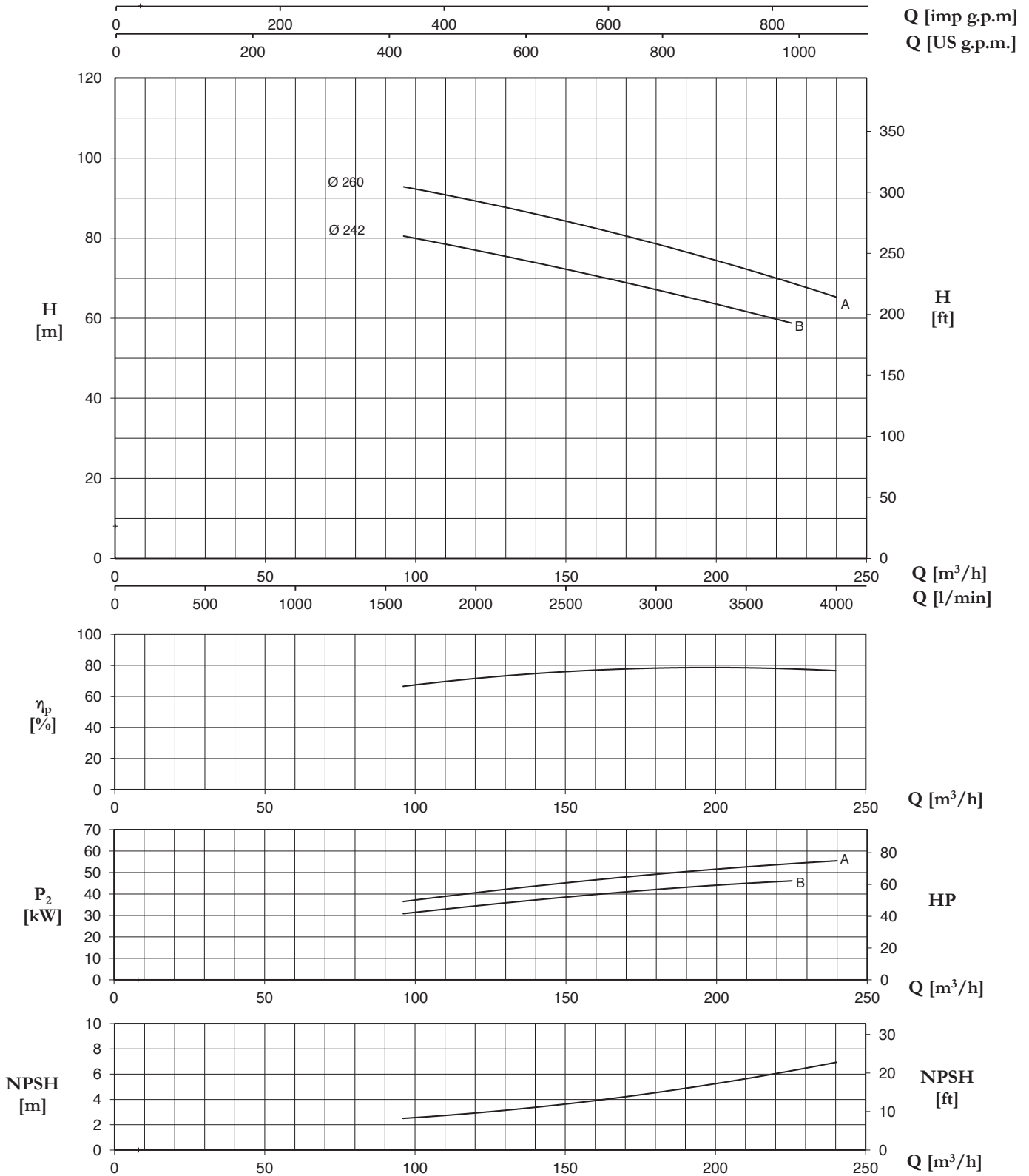

Tolerance: ISO 9906:2012 - Grade 3B

TYPE	Nominal Power (kW)	Motor Size	Q (m³/h - l/min)										
			0	96	108	120	144	168	180	195	210	225	240
			0	1600	1800	2000	2400	2800	3000	3250	3500	3750	4000
H (m) / pump input power (kW)													
80-250 B	45	225M	77,2	80,0	79,0	77,5	73,1	69,0	67,0	64,5	61,8	58,8	
			14,00	30,93	32,60	34,34	37,86	40,78	42,10	43,60	44,94	46,16	
80-250 A	55	250M	90,0	92,8	91,1	89,3	85,4	80,7	78,5	75,7	72,4	68,8	65,2
			16,75	36,55	38,57	40,54	44,31	47,80	49,29	50,93	52,59	54,17	55,50

**CA/CAT - CAX/CATX EN 733 ~ 2900 r.p.m.**

**80-315**

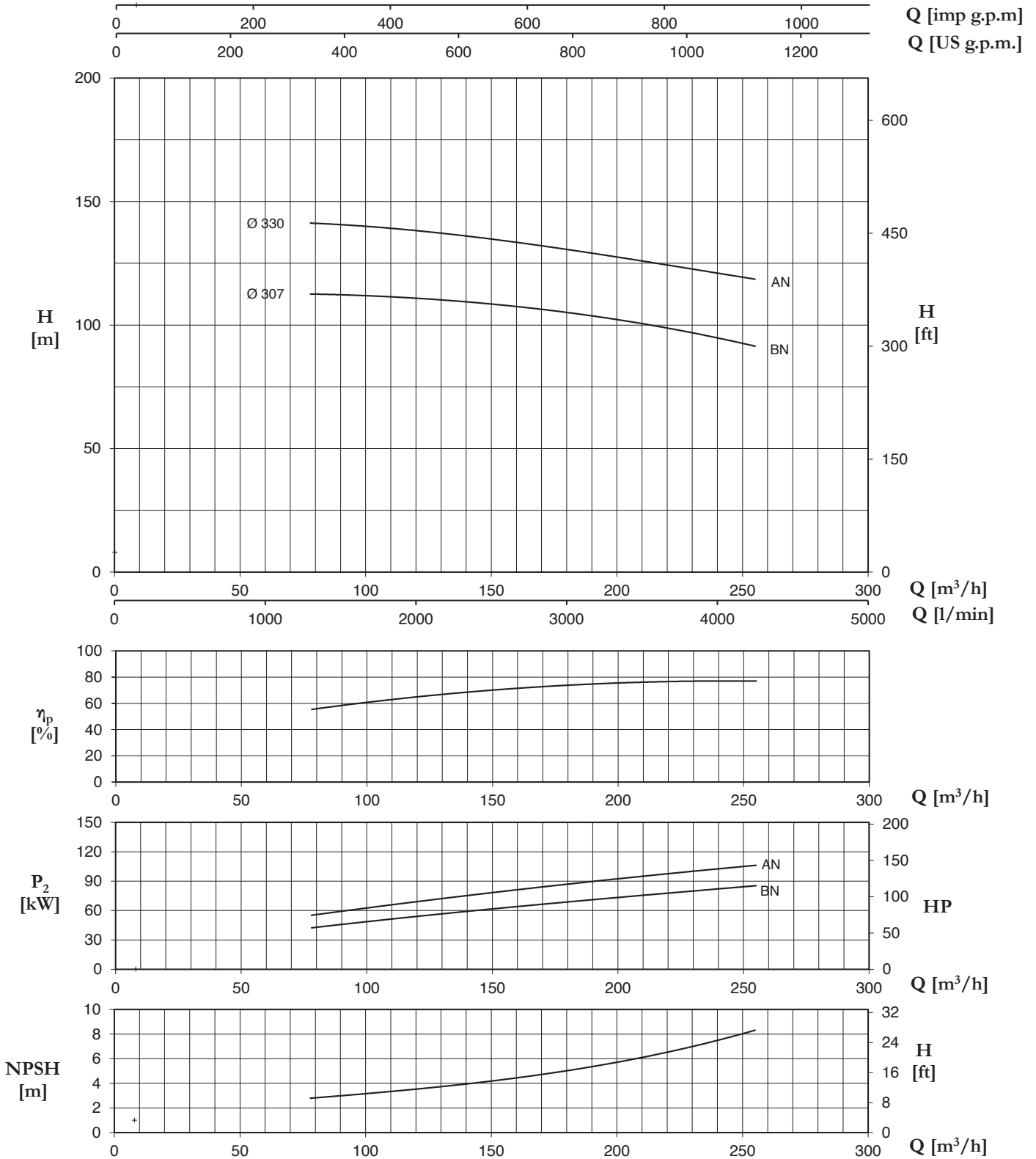

Tolerance: ISO 9906:2012 - Grade 3B

TYPE	Nominal Power (kW)	Motor Size	Q (m³/h - l/min)									
			0	78	96	120	144	168	195	225	255	
			0	1300	1600	2000	2400	2800	3250	3750	4250	
H (m) / pump input power (kW)												
80-315BN	90	280M	108,0 21,85	112,4 42,35	112,2 47,49	111,1 54,13	109,1 60,24	106,4 65,95	102,7 72,14	98,3 78,97	90,8 85,17	
80-315AN	110	315M	140,5 31,92	141,4 55,48	140,2 61,13	138,1 68,78	135,5 76,96	132,5 84,36	128,7 90,23	122,5 99,35	118,5 106,15	

# 100-200

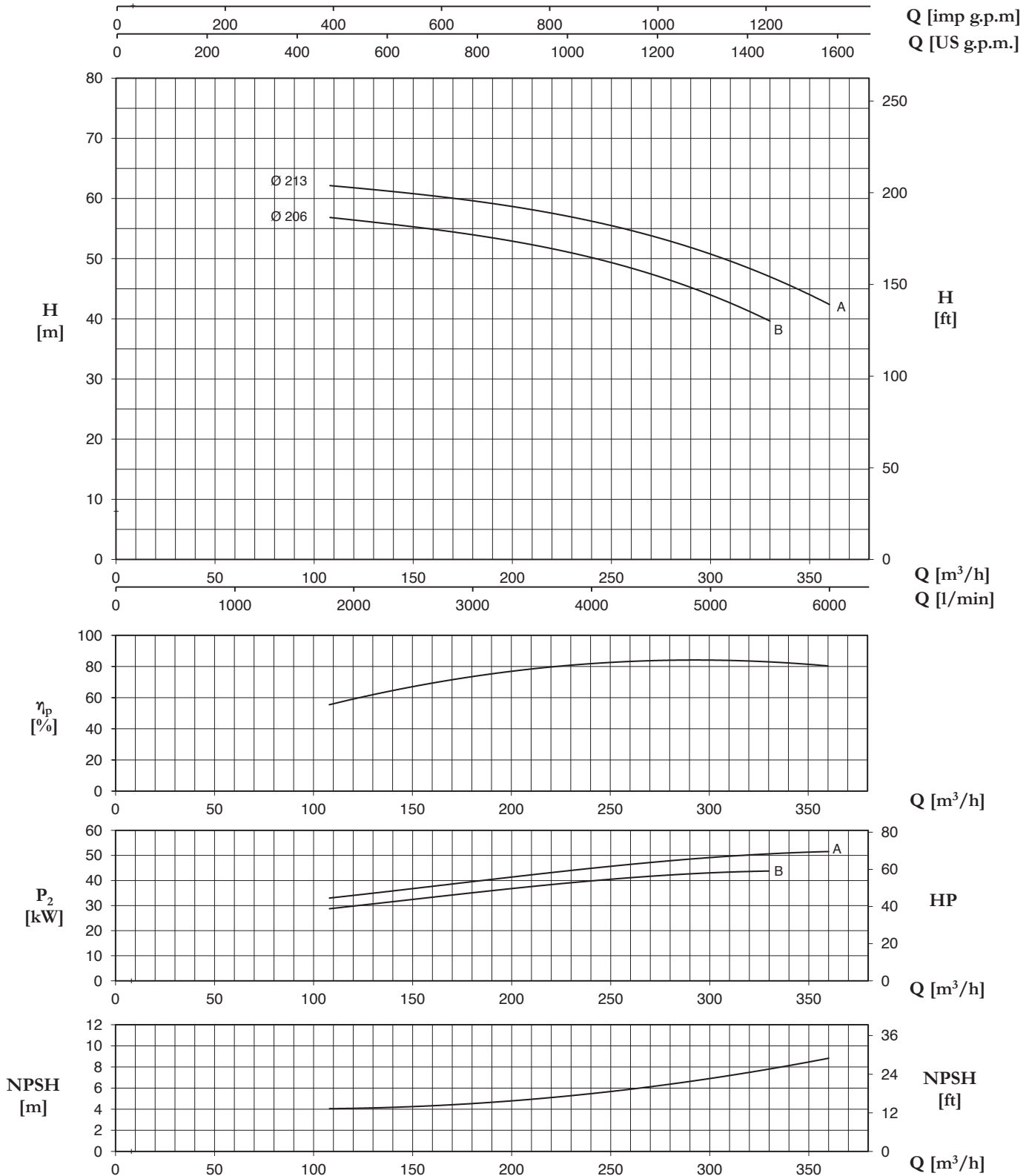

Tolerance: ISO 9906:2012 - Grade 3B

TYPE	Nominal Power (kW)	Motor Size	Q (m³/h - l/min)										
			0	108	144	168	210	225	240	270	300	330	360
			0	1800	2400	2800	3500	3750	4000	4500	5000	5500	6000
H (m) / pump input power (kW)													
100-200 B	45	225M	56,1	56,8	55,6	54,5	52,2	51,4	50,4	47,5	43,8	39,7	
			21,75	28,84	31,75	33,89	37,81	38,89	39,85	41,59	42,92	43,82	
100-200 A	55	250M	61,1	62,2	61,0	59,9	58,3	57,4	56,4	53,8	50,6	46,8	42,5
			24,57	33,04	36,18	38,39	42,24	43,60	44,97	47,28	49,05	50,52	51,61

# 100-250

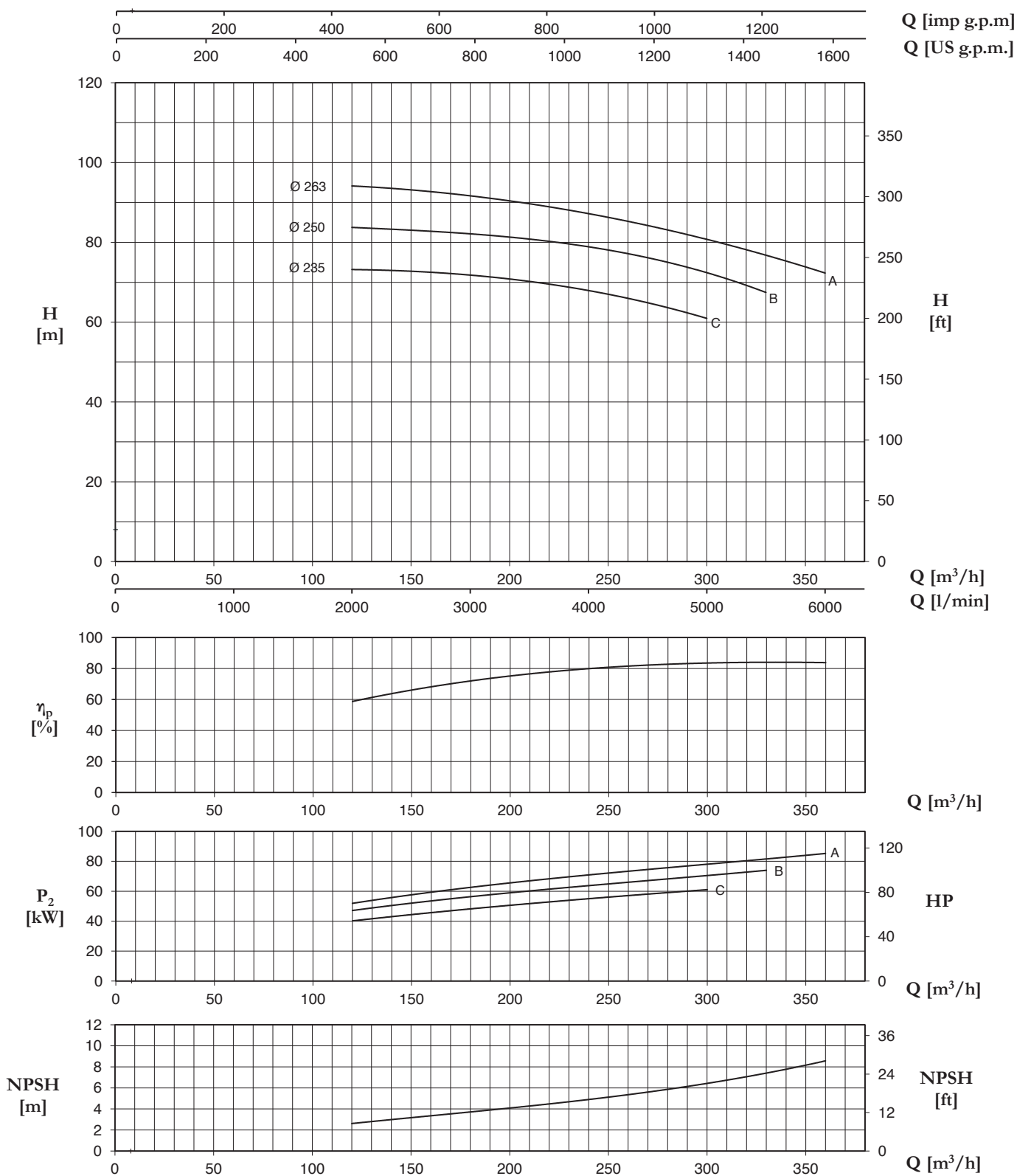

Tolerance: ISO 9906:2012 - Grade 3B

TYPE	Nominal Power (kW)	Motor Size	Q (m³/h - l/min)										
			0	120	144	168	210	225	255	270	300	330	360
			0	2000	2400	2800	3500	3750	4250	4500	5000	5500	6000
H (m) / pump input power (kW)													
100-250 C	55	250M	71,9	73,2	72,9	72,2	70,3	69,3	66,4	64,7	61,0		
	75	280S	24,75	40,12	43,70	46,77	51,65	53,38	56,67	58,19	60,99		
100-250 B	75	280S	83,6	83,7	83,2	82,5	80,8	80,0	77,9	76,4	72,0	67,6	
			29,69	47,10	51,01	54,76	60,25	61,86	65,15	66,93	70,90	73,78	
100-250 A	90	280M	93,5	93,9	93,4	92,4	89,9	88,8	87,4	85,8	80,4	75,8	73,2
			32,72	51,98	56,31	60,59	66,97	68,83	70,82	72,83	78,16	81,33	85,53

**~ 2900 r.p.m. CA/CAT - CAX/CATX EN 733**  
**~ 1450 r.p.m. 4CA/4CAT - 4CAX/4CATX EN 733**

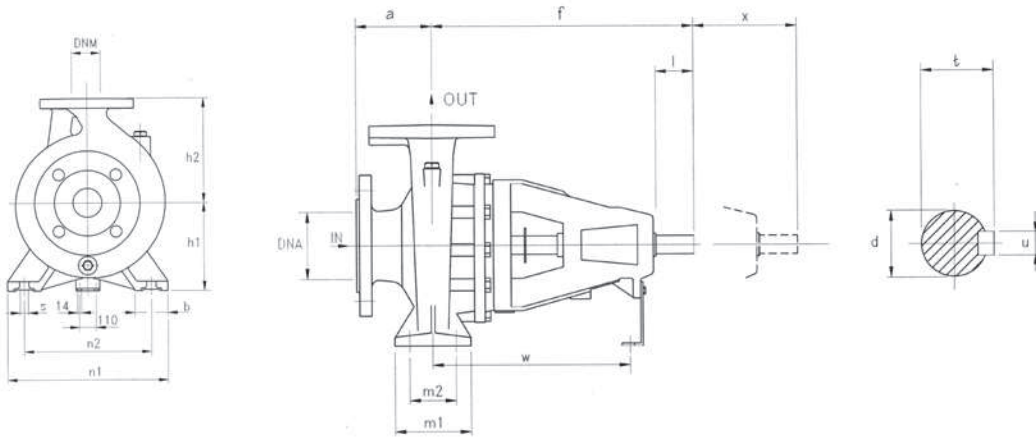

TYPE	DIMENSIONS (mm)																						Kg
	DNA	DNM	a	f	h1	h2	m1	m2	n1	n2	s	b	l	d	t	u	x	w	I	L	M		
32-160	50	32	80	360	132	160	100	70	240	190	14	50	50	24	27	8	100	260	535	320	445	38	
32-200			80	360	160	180	100	70	240	190	14	50	50	24	27	8	100	260	535	320	445	41	
32-250			100	360	180	225	125	95	320	250	14	65	65	24	27	8	100	260	680	405	545	50	
40-125	65	40	80	360	112	140	100	70	210	160	14	50	50	24	27	8	100	260	535	320	445	37	
40-160			80	360	132	160	100	70	240	190	14	50	50	24	27	8	100	260	535	320	445	40	
40-200			100	360	160	180	100	70	265	212	14	50	50	24	27	8	100	260	535	320	445	44	
40-250			100	360	180	225	125	95	320	250	14	65	50	24	27	8	100	260	680	405	545	50	
40-315			125	470	200	250	125	95	345	280	14	65	80	32	35,3	10	100	340	655	465	620	84	
50-125	65	50	100	360	132	160	100	70	240	190	14	50	50	24	27	8	100	260	535	320	445	40,5	
50-160			100	360	160	180	100	70	265	212	14	50	50	24	27	8	100	260	535	320	445	44	
50-200			100	360	160	200	100	70	265	212	14	50	50	24	27	8	100	260	535	320	445	47	
50-250			100	360	180	225	100	95	320	250	14	65	50	24	27	8	100	260	680	405	545	54	
50-315			80	125	470	225	280	125	95	345	280	14	65	80	32	35,3	10	100	340	655	465	620	82
65-125	80	65	100	360	160	180	125	95	280	212	14	65	65	24	27	8	100	260	535	320	445	41	
65-160			100	360	160	200	125	95	280	212	14	65	65	24	27	8	100	260	535	320	445	49	
65-200			100	360	180	225	125	95	320	250	14	65	65	24	27	8	140	260	680	405	545	53	
65-250			100	470	200	250	160	120	360	280	19	80	80	32	35	10	140	340	680	405	545	76,5	
65-315			125	470	225	280	160	120	400	315	19	80	80	32	35	10	140	340	655	465	620	94	
80-160	100	80	125	360	180	225	125	95	320	250	14	65	50	24	27	8	140	260	680	405	545	58	
80-200			125	470	180	250	125	95	345	280	14	65	80	32	35	10	140	340	680	405	545	73	
80-250			125	470	200	280	160	120	400	315	18	80	80	32	35,3	10	140	340	655	465	585	82	
80-315			125	470	250	315	160	120	400	315	18	80	80	32	35,3	10	140	340	655	465	620	97	
100-200	125	100	125	470	200	280	160	120	360	286	18	80	80	32	35,3	10	140	340	655	465	620	74	
100-250			140	470	225	280	160	120	400	315	18	80	80	32	35,3	10	140	340	655	465	620	94	
100-315			140	470	250	315	160	120	400	315	18	80	80	32	35,3	10	140	340	655	465	620	115	
100-400			140	530	280	355	200	150	500	400	22	100	110	42	45,3	12	140	370	720	775	855	170	
125-250	150	125	160	530	315	450	200	150	550	450	22	100	110	42	45,3	12	140	370	655	465	620	180	
125-315			140	530	280	355	200	150	500	400	22	100	110	42	45,3	12	140	370	720	775	855	150	
125-400			140	530	315	400	200	150	500	400	22	100	110	42	45,3	12	140	370	720	775	855	180	
150-315	200	150	160	530	280	400	200	150	550	450	22	100	110	42	45,3	12	140	370	655	465	620	164	
150-400	200	150	160	530	315	450	200	150	550	450	22	100	110	42	45,3	12	140	370	720	775	855	220	

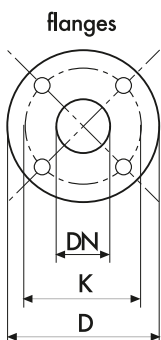

DIMENSIONS (mm)				
DN	D	K	holes	
			n°	Ø
32	140	100	4	18
40	150	110	4	18
50	165	125	4	18
65	185	145	4	18
80	200	160	8	18
100	220	180	8	18
125	250	210	8	18
150	285	240	8	23
200	340	295	8	23

**CA/CAT - CAX/CATX** EN 733 ~ 2900 r.p.m.

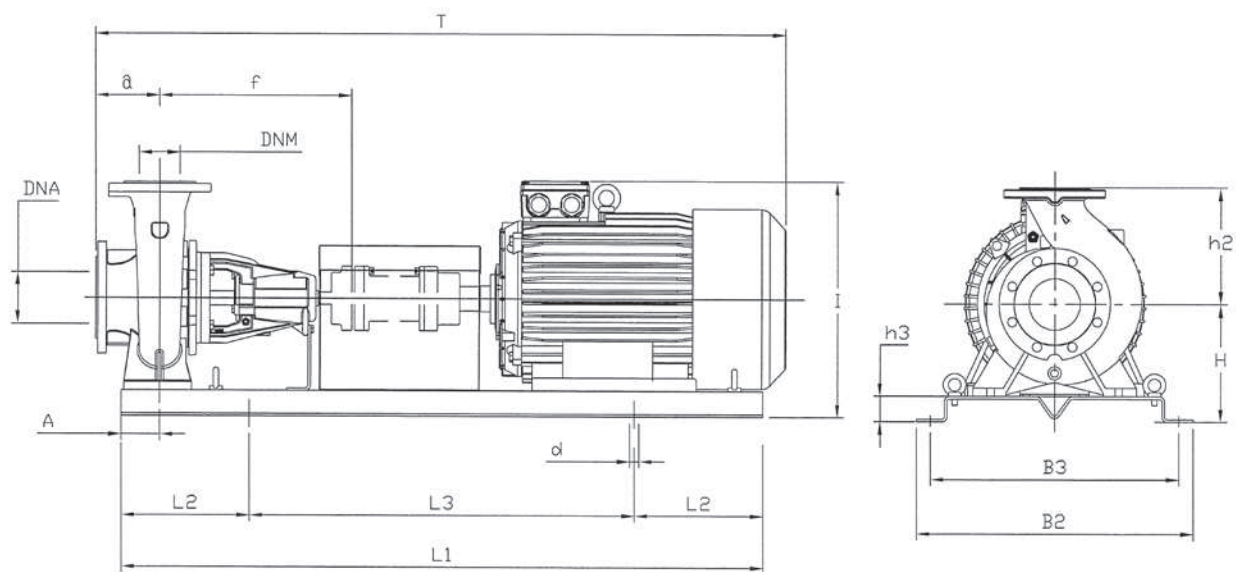

**~ 2900 r.p.m. CA/CAT - CAX/CATX EN 733**

TYPE	kW	Motor Size	DIMENSIONS (mm)																Kg
			DNA	DNM	a	f	H	h2	h3	L1	L2	L3	B2	B3	A	d	T	I	
32-160C	1,5	90S	50	32	80	360	182	160	50	800	130	540	390	320	60	18	951	375	50,5
32-160C	2,2	90L	50	32	80	360	182	160	50	900	150	600	390	350	60	18	951	375	54
32-160B	2,2	90L	50	32	80	360	182	160	50	900	150	600	390	350	60	18	951	375	54
32-160A	3	100L	50	32	80	360	182	160	50	900	150	600	390	350	60	18	951	375	61
32-160A	4	112M	50	32	80	360	182	160	50	900	150	600	390	350	60	18	951	375	65,5
32-200C	4	112M	50	32	80	360	210	180	50	900	150	600	390	350	60	18	951	420	68,5
32-200C	5,5	132S	50	32	80	360	210	180	50	1000	170	660	450	400	60	22	1051	420	80
32-200B	5,5	132S	50	32	80	360	210	180	50	1000	170	660	450	400	60	22	1051	420	80
32-200B	7,5	132S	50	32	80	360	210	180	50	1000	170	660	450	400	60	22	1051	420	84
32-200A	7,5	132S	50	32	80	360	210	180	50	1000	170	660	450	400	60	22	1051	420	84
32-200A	11	160M	50	32	80	360	210	180	50	1000	170	660	490	400	60	22	1181	465	150
32-250C	11	160M	50	32	100	360	230	225	50	1250	205	840	540	490	75	22	1306	485	159
32-250B	11	160M	50	32	100	360	230	225	50	1250	205	840	540	490	75	22	1306	485	159
32-250B	15	160M	50	32	100	360	230	225	50	1250	205	840	540	490	75	22	1306	485	169
32-250A	15	160M	50	32	100	360	230	225	50	1250	205	840	540	490	75	22	1306	485	169
40-125C	1,5	90S	65	40	80	360	162	140	50	800	130	540	390	320	60	18	955	332	49,5
40-125C	2,2	90L	65	40	80	360	162	140	50	800	130	540	390	320	60	18	955	332	53
40-125B	2,2	90L	65	40	80	360	162	140	50	800	130	540	390	320	60	18	955	332	53
40-125A	3	100L	65	40	80	360	162	140	50	900	150	600	390	350	60	18	955	332	60
40-160B	3	100L	65	40	80	360	182	160	50	900	150	600	390	350	60	18	955	372	63
40-160B	4	112M	65	40	80	360	182	160	50	900	150	600	390	350	60	18	955	372	67,5
40-160A	4	112M	65	40	80	360	182	160	50	900	150	600	390	350	60	18	955	372	67,5
40-160A	5,5	132S	65	40	80	360	182	160	50	1000	170	660	450	400	60	22	1055	388	79
40-200B	5,5	132S	65	40	100	360	210	180	50	1000	170	660	450	400	60	22	1075	416	83
40-200A	7,5	132S	65	40	100	360	210	180	50	1000	170	660	450	400	60	22	1075	416	87
40-250C	11	160M	65	40	100	360	230	225	50	1250	205	840	540	490	75	22	1310	485	159
40-250B	11	160M	65	40	100	360	230	225	50	1250	205	840	540	490	75	22	1310	485	159
40-250B	15	160M	65	40	100	360	230	225	50	1250	205	840	540	490	75	22	1310	485	169
40-250A	15	160M	65	40	100	360	230	225	50	1250	205	840	540	490	75	22	1310	485	169
40-250A	18,5	160L	65	40	100	360	230	225	50	1250	205	840	540	490	75	22	1310	485	186
50-125B	3	100L	65	50	100	360	182	160	50	900	150	600	390	350	60	18	975	373	63,5
50-125B	4	112M	65	50	100	360	182	160	50	900	150	600	390	350	60	18	985	373	68
50-125A	4	112M	65	50	100	360	182	160	50	900	150	600	390	350	60	18	985	373	68
50-125A	5,5	132S	65	50	100	360	182	160	50	1000	170	660	450	400	60	22	1078	388	79,5
50-160B	5,5	132S	65	50	100	360	210	180	50	1000	170	660	450	400	60	22	1078	421	83
50-160A	7,5	132S	65	50	100	360	210	180	50	1000	170	660	450	400	60	22	1078	421	87
50-200C	11	160M	65	50	100	360	210	200	50	1000	170	660	490	400	60	22	1210	465	156
50-200B	11	160M	65	50	100	360	210	200	50	1120	190	740	490	440	60	22	1210	465	156
50-200A	15	160M	65	50	100	360	210	200	50	1120	190	740	490	440	60	22	1210	465	166
50-250C	15	160M	65	50	100	360	230	225	50	1250	205	840	540	490	75	22	1310	486	173
50-250C	18,5	160L	65	50	100	360	230	225	50	1250	205	840	540	490	75	22	1310	486	190
50-250B	18,5	160L	65	50	100	360	230	225	50	1250	205	840	540	490	75	22	1310	486	190
50-250B	22	180M	65	50	100	360	230	225	50	1250	205	840	540	490	75	22	1358	502	226
50-250A	22	180M	65	50	100	360	230	225	50	1250	205	840	540	490	75	22	1358	502	226
50-250A	30	200L	65	50	100	360	230	225	50	1400	230	940	540	550	75	26	1383	522	277
65-125B	5,5	132S	80	65	100	360	210	180	50	1000	170	660	450	400	75	22	1081	425	80
65-125A	7,5	132S	80	65	100	360	210	180	50	1000	170	660	450	400	75	22	1081	425	84
65-160C	11	160M	80	65	100	360	210	200	50	1120	190	740	490	440	75	22	1213	465	158
65-160B	11	160M	80	65	100	360	210	200	50	1120	190	740	490	440	75	22	1213	465	158
65-160A	15	160M	80	65	100	360	210	200	50	1120	190	740	490	440	75	22	1213	465	168
65-200C	15	160M	80	65	100	360	230	225	50	1250	205	840	540	490	75	22	1313	490	172
65-200B	18,5	160L	80	65	100	360	230	225	50	1250	205	840	540	490	75	22	1313	490	189
65-200A	22	180M	80	65	100	360	230	225	50	1250	205	840	540	490	75	22	1418	502	225
65-250B	30	200L	80	65	100	470	250	250	50	1400	230	940	610	550	90	26	1523	535	299,5
65-250A	37	200L	80	65	100	360	250	250	50	1400	230	940	610	550	90	26	1523	535	318,5
80-160E	11	160M	100	80	125	360	230	225	50	1120	190	740	540	440	75	22	1343	493	167
80-160D	11	160M	100	80	125	360	230	225	50	1250	205	840	540	490	75	22	1343	493	167
80-160C	15	160M	100	80	125	360	230	225	50	1250	205	840	540	490	75	22	1343	493	177
80-160B	18,5	160L	100	80	125	360	230	225	50	1250	205	840	540	490	75	22	1343	493	194
80-160A	22	180M	100	80	125	360	230	225	50	1250	205	840	540	490	75	22	1448	502	230
80-200B	30	200L	100	80	125	470	250	250	50	1400	230	940	610	550	75	26	1593	538	296
80-200A	37	200L	100	80	125	470	250	250	50	1400	230	940	610	550	75	26	1593	538	315
80-250B	45	225M	100	80	125	470	275	280	50	1400	230	940	610	550	90	26	1540	605	420
80-250A	55	250M	100	80	125	470	335	280	85	1600	270	1060	660	600	90	26	1650	710	550
80-315BN	90	280M	100	80	125	470	365	315	85	1800	300	1200	730	670	90	26	1770	770	745
80-315AN	132	315M	100	80	125	470	465	315	150	1950	-	-	800	-	90	-	2030	-	1200
100-200B	45	225M	125	100	125	470	275	280	50	1400	230	940	610	550	90	26	1540	605	412
100-200A	55	250M	125	100	125	470	335	280	85	1600	270	1060	660	600	90	26	1650	710	542
100-250C	55	250M	125	100	140	470	335	280	85	1600	270	1060	660	600	90	26	1665	710	562
100-250C	75	280S	125	100	140	470	365	280	85	1800	300	1200	730	670	90	26	1740	770	703
100-250B	75	280S	125	100	140	470	365	280	85	1800	300	1200	730	670	90	26	1740	770	703
100-250A	90	280M	125	100	140	470	365	280	85	1800	300	1200	730	670	90	26	1785	770	733