

Soprema Group danas je jedan od vodećih svjetskih proizvođača za proizvodnju materijala za pokrivanje bazena i vodonepropusne sustave, prisutna u preko 90 zemalja diljem svijeta.

FLAGPOOL pvc bazenske obloge zahvaljujući svojim visokim performansama i uvjetima hidroizolacije, mehaničke otpornosti, mekoće i fleksibilnosti dizajnirane su za vodonepropusnost, zaštitu i ukrašavanje bazena, rješenje za nove strukture i obnovu već postojećih. FLAGPOOL pvc bazenske obloge uvijek osiguravaju savršene estetske rezultate te su prikladne za svaki potporni element bazena: beton, prefabricirani beton, prefabriciran s metalnim pločama... Mogu se koristiti za pokrivanje privatnih ili javnih bazena kao i za vodene parkove. Glavne značajke su sljedeće:

- Visoka otpornost na atmosferske čimbenike te UV zrake
- velika otpornost na mikroorganizme
- visoka mehanička otpornost, otpornost na probijanje
- neosjetljivost na tople i hladne cikle
- odličan kapacitet zavarivanja
- otpornost na standardne kemikalije za obradu vode u bazenima



FLAGPOOL NG11 GLOSSY UNICOLOR PRINTED decorative borders version with SPECIAL LAQUERING FINISHING available in: Maiorca, Creta, Rodi, Minorca

The special LAQUERING on the visible surface of FLAGPOOL PVC liner ensures a better resistance to light, to the attack of any microorganism (funguses, bacteria, spores) and to sun creams and lotions. This allows reducing the cleaning interventions and prolongs the life of your swimming pool.

FLAGPOOL fully complies the European standard EN 15836-2/2010.

FLAGPOOL NG11 GLOSSY PRINTED unicolor 1.5mm thick liners made with reinforced glass fiber. Liner roll length 25m, height 17,2cm



Code	Description	PKG	WGT
160501	A Flagpool decorative border Minorca 17,2cm x 1,5mm	25	1,8
160502	A Flagpool decorative border Maiorca 17,2cm x 1,5mm	25	1,8
160503	A Flagpool decorative border Creta 17,2cm x 1,5mm	25	1,8
160504	A Flagpool decorative border Rodi 17,2cm x 1,5mm	25	1,8

FLAGPOOL NG11 UNICOLOR

FLAGPOOL NG11 UNICOLOR with standard finishing available in: light blue, light sky blue, sand, white, pearl grey, dark grey, anthracite black, aqua green, caribbean green, pink marmorino.

FLAGPOOL fully complies the European standard EN 15836-2/2010.

FLAGPOOL NG11 GLOSSY PRINTED unicolor 1.5mm thick liners made with reinforced glass fiber. Liner roll length 25m, width 1,6m

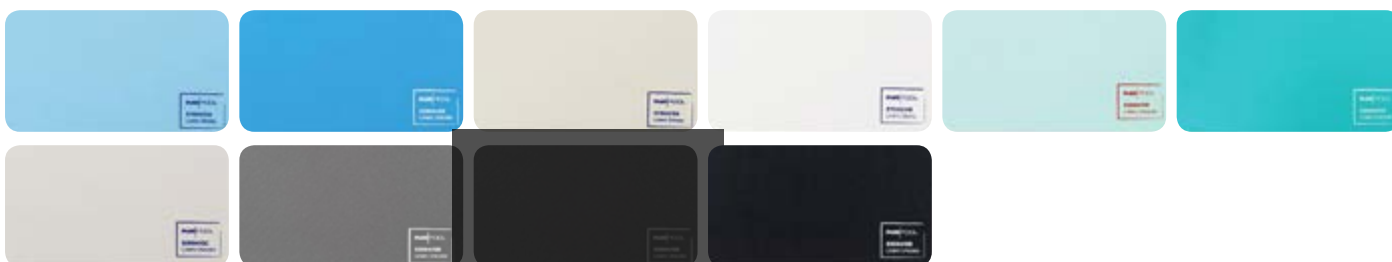

Code	Description	PKG	WGT
160001	B Flagpool Light Blue 1,5mm	104140/CA	41,25 1,8
160002	B Flagpool Sky Blue 1,5mm	104140/AB	41,25 1,8
160003	B Flagpool Dark Blue 1,5mm	104140/DB	41,25 1,8
160004	B Flagpool Sand 1,5mm	104140/SA	41,25 1,8
160005	B Flagpool White 1,5mm	104140/HB	41,25 1,8
160006	B Flagpool Aqua Green 1,5mm	104140/VD	41,25 1,8
160007	B Flagpool Caribbean Green 1,5mm	104140/VC	41,25 1,8
160009	B Flagpool Pearl Grey 1,5mm	104140/GC	41,25 1,8
160010	B Flagpool Dark Grey 1,5mm	104140/GB	41,25 1,8
160013	B Flagpool Basalt Grey 1,5mm	104140/GA	41,25 1,8
160011	B Flagpool Anthracite 1,5mm	104140/NB	41,25 1,8

FLAGPOOL NG11 UNICOLOR, GLOSSY

FLAGPOOL NG11 GLOSSY UNICOLOR coloured version with SPECIAL LAQUERING FINISHING available in: Light blue, sky blue, sand, and white (other colours available on request); The special LAQUERING on the visible surface of FLAGPOOL PVC liner ensures a better resistance to light, to the attack of any microorganism (funguses, bacteria, spores) and to sun creams and lotions. This allows reducing the cleaning interventions and prolongs the life of your swimming pool.

FLAGPOOL fully complies the European standard EN 15836-2/2010.

FLAGPOOL NG11 GLOSSY PRINTED unicolor 1.5mm thick liners made with reinforced glass fiber. Liner roll length 25m, width 1,6m.

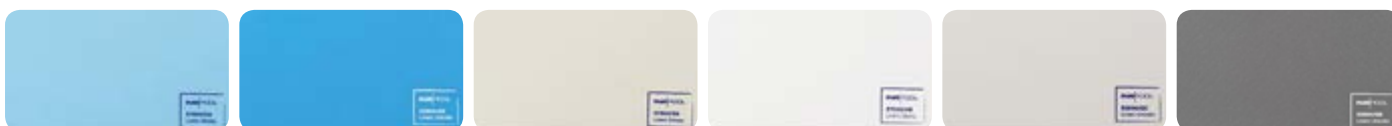

Code	Description	PKG	WGT
160101	B Flagpool Glossy Light blue 1,5mm	108068/CA	41,25 1,8
160102	B Flagpool Glossy Sky Blue 1,5mm	108068/AB	41,25 1,8
160104	B Flagpool Glossy Sand 1,5mm	108068/SA	41,25 1,8
160105	B Flagpool Glossy White 1,5mm	108068/HB	41,25 1,8
160109	B Flagpool Glossy Pearl Grey 1,5mm	108068/GC	41,25 1,8
160110	B Flagpool Glossy Dark Grey 1,5mm	108068/GB	41,25 1,8

FLAGPOOL NG11 GLOSSY PRINTED

FLAGPOOL NG11 GLOSSY UNICOLOR PRINTED version with SPECIAL LAQUERING FINISHING available in: blue mosaic – green mosaic – Marbella Blue – Pearl Black, White Florence, Sky Blue, Stones, Marbella Gold et Gold Mosaic. The special LAQUERING on the visible surface of FLAGPOOL PVC liner ensures a better resistance to light, to the attack of any microorganism (funguses, bacteria, spores) and to sun creams and lotions. This allows reducing the cleaning interventions and prolongs the life of your swimming pool. FLAGPOOL fully complies the European standard EN 15836-2/2010 FLAGPOOL NG11 GLOSSY PRINTED unicolor 1.5mm thick liners made with reinforced glass fiber. Liner roll length 25m, width 1,6m

* The width of the liners may change to 1,65m depending on stock!

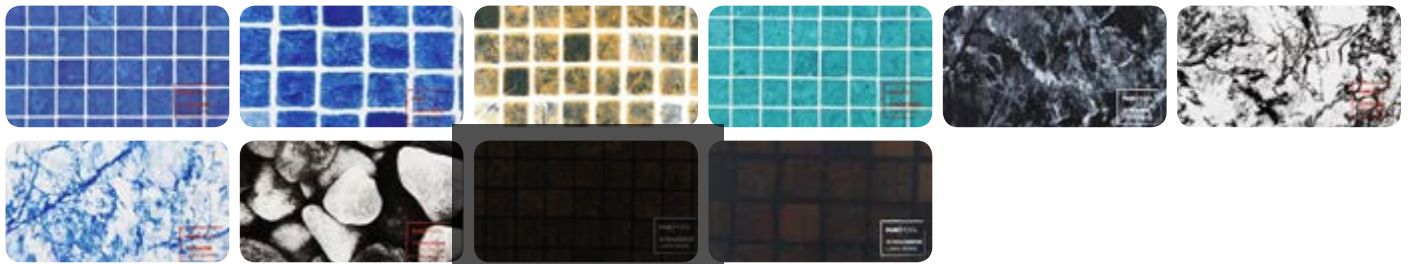

Code	Description	PKG	WGT
160251	B Flagpool Blue Mosaic 1,5mm	57504/MNB	41,25 1,8
160252	B Flagpool Marbella Mosaic 1,5mm	57504/MMB	41,25 1,8
160260	B Flagpool Alhambra Mosaic 1,5mm	57504/MSI	41,25 1,8
160253	B Flagpool Green Mosaic 1,5mm	57504/MNG	41,25 1,8
160254	B Flagpool Marble Pearl Black 1,5mm	57504/PB	41,25 1,8
160255	B Flagpool Marble White Florence 1,5mm	57504/WF	41,25 1,8
160256	B Flagpool Marble Sky Blue 1,5mm	57504/SB	41,25 1,8
160257	B Flagpool Stone 1,5mm	57504/STON	41,25 1,8
160258	B Flagpool Gold Mosaic 1,5mm	57504/GOLD	41,25 1,8
160259	B Flagpool Marbella Gold Mosaic 1,5mm	57504/MMGO	41,25 1,8

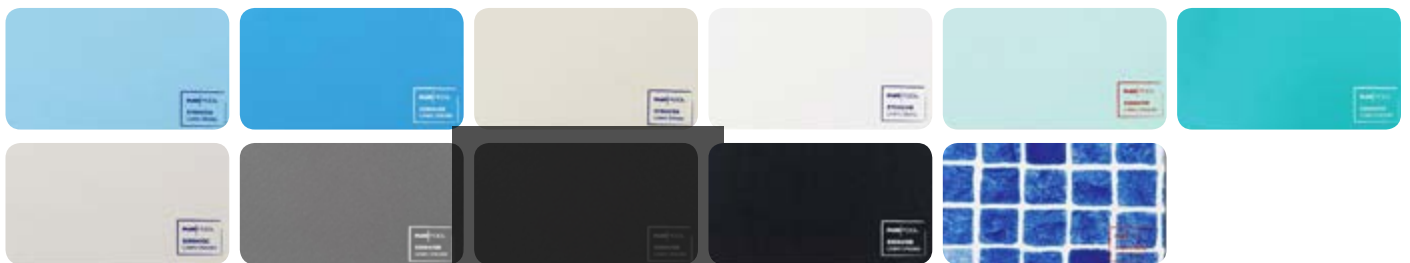

Code	Description	PKG	WGT
160301	B Flagpool Antislip Light Blue 1,5mm	101184/CA	15 1,8
160302	B Flagpool Antislip Sky Blue 1,5mm	101184/AB	15 1,8
160303	B Flagpool Antislip Navy Blue 1,5mm	101184/DB	15 1,8
160304	B Flagpool Antislip Sand 1,5mm	101184/SA	15 1,8
160305	B Flagpool Antislip White 1,5mm	101184/HB	15 1,8
160306	B Flagpool Antislip Aqua Green 1,5mm	101184/VD	15 1,8
160307	B Flagpool Antislip Caribbean Green 1,5mm	101184/VC	15 1,8
160309	B Flagpool Antislip Pearl Grey 1,5mm	107949/GC	15 1,8
160310	B Flagpool Antislip Dark Grey 1,5mm	101184/GB	15 1,8
160313	B Flagpool Antislip Basalt Grey 1,5mm	107949/NB	15 1,8
160311	B Flagpool Antislip Anthracite 1,5mm	107949/GA	15 1,8
160352	B Flagpool Antislip Marbella Mosaic 1,5mm	101184/MMB	15 1,8

ACCESSORIES



Code	Description	PKG	WGT
160601	A Flagpool Swimming lane markers 1,5mm; 25 cm x 25 m	25m	
160602	A Flagpool Swimming lane markers - Antislip - 1,5mm; 25 cm x 20 m	20m	



Code	Description	PKG	WGT
160400	B Flagpool liquid PVC Transparent 1l	1	1
160401	B Flagpool liquid PVC Light Blue 1l	1	1
160402	B Flagpool liquid PVC Sky Blue 1l	1	1
160403	B Flagpool liquid PVC Navy Blue 1l	1	1
160404	B Flagpool liquid PVC Sand 1l	1	1
160405	B Flagpool liquid PVC White 1l	1	1
160406	B Flagpool liquid PVC Aqua Green 1l	1	1
160407	B Flagpool liquid PVC Caribbean Green 1l	1	1
160409	B Flagpool liquid PVC Pearl Grey 1l	1	1
160410	B Flagpool liquid PVC Dark Grey 1l	1	1
160411	B Flagpool liquid PVC Anthracite 1l	1	1
160413	B Flagpool liquid PVC Basalt Grey 1l	1	1



Code	Description	PKG	WGT
160423	A Flagpool THF Solvent 3l	1	
160425	A Varioplast 3215, 850g	1	
165010	B Double-Coated Adhesive Tape 9mm x 50m	1	
165041	B Gray liner fixer 4/1cm	1	0,54
165052	B Gray liner fixer 5/2cm	1	0,74
165082	B Gray liner fixer 8/2cm	1	1,08
165004	B Gray liner fixer 4cm	1	0,42
165005	B Gray liner for Porocell overflow channel inner side	1	1,32
165006	B Gray liner for Porocell overflow channel outer side	1	1,04
165600	F Geotextile, heat treated 300gr/m2; 2.55 x 50m/roll - 127.5m2	1	
160499	B Applicator for liquid PVC	1	

THE CGT MEMBRANE ADVANTAGE

Our membranes are very robust which are resistant to scratches, chlorine, UV etc. We are a company with over 50 years of experience in the pool business.

All of CGT's products are varnished with multi-layer varnish, which makes them resistant to chlorine, UV, stains and color loss.

Our Aquasense patterns are unique in the market because of the quality and the realism of its emboss, the varnish we apply (also multi-layer) and the flexibility they have thanks to their 1.6mm thickness.

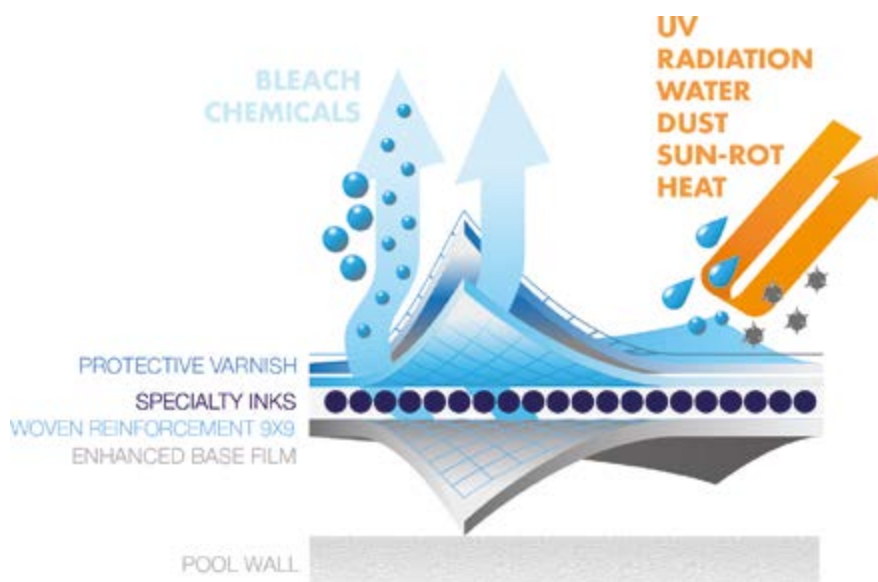

- **Premium PVC-P formula**
- **High quality multi-layer varnish**
- **Certification to NFP 15 836-1 and NFP 15 836-2**
- **Leading printing capability**

Code	Description	PKG	WGT
161030	B 3D Black Slate	20 x 1,65m	
161031	B 3D Sand Riviera	20 x 1,65m	
161032	B 3D Mosaic	20 x 1,65m	
161430	B CGT liquid PVC Anthracit Grey	6	
161431	B CGT liquid PVC Sand	6	
161432	B CGT liquid PVC French Blue	6	
160422	A CGT THF Solvent 1l	6	

BLACK SLATE

3D Slate Stone Finish



GOLDEN RIVIERA

3D Beach Sand Finish



3D MOSAIC

3D Mosaic Tile Finish



GRANITE KERBSTONE

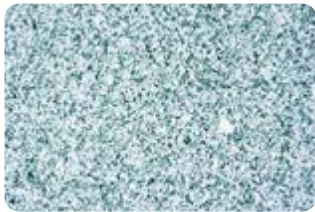

SILVER GRAY



ANTRAZIT



SAND

Natural granite pool kerbstone with rounded inner side, with flamed antislip surface.

Available in two sizes :

- Straight kerbstones: 100 x 25 x 3cm – Corner: 50 x 50/25 x 3cm
- Straight kerbstones: 100 x 33 x 3cm – Corner 50 x 50/33 x 3cm



Code	Description	PKG	WGT
167001	A Granite kerbstone Silver 100 x 33 x 3 cm	1	30,4
167002	A Granite kerbstone Silver 100 x 25 x 3 cm	1	23
167011	A Granite kerbstone corner Silver 50 x 50 / 33 * 3 cm	1	
167012	A Granite kerbstone corner Silver 50 x 50 / 25 * 3 cm	1	
167101	A Granite kerbstone Antracit 100 x 33 x 3 cm	1	30,4
167102	A Granite kerbstone Antracit 100 x 25 x 3 cm	1	23
167111	A Granite kerbstone corner Antracit 50 x 50 / 33 * 3 cm	1	
167112	A Granite kerbstone corner Antracit 50 x 50 / 25 * 3 cm	1	
167201	A Granite kerbstone Sand 100 x 33 x 3 cm	1	30,4
167202	A Granite kerbstone Sand 100 x 25 x 3 cm	1	23
167211	A Granite kerbstone corner Sand 50 x 50 / 33 * 3 cm	1	
167212	A Granite kerbstone corner Sand 50 x 50 / 25 * 3 cm	1	



POROCELL BAZENSKI BLOKOVI

Prednosti bazena izrađenih od Porocell blokova :

Zbog svoje jednostavne metode i prilagodbe prikladni su za oblikovanje i izolacija neće biti potrebna. Blokovi koji čine sustav su izrađene od ekstrudiranog polistrena velike gustoće i mogu se rezati pilom ili 25 cm nožem .Svaka komponenta bazena, kao što su skimmer, mlaznica, protustrujna instalacija , lako se i precizno može integrirati. Ova fleksibilna obradivost omogućuje veliku slobodu stvaranja oblika bazena, prilagođavajući se njegovim dimenzijama.

Na armirano-betonskoj podlozi postavljamo opeke koje čine sustav, potom se ojačavaju elementima za pojačanje i nadopunjuju s betonom . Sloj geotekstila postavljen je na zidove i na dno bazena. U slučaju da izolirate bazenske rubove s montažnom folijom, tada moramo fiksirati plastični profil koji omogućuje lako postavljanje bazenske folije . Ovi porocell blokovi pridonose bržem zagrijavanju vode u bazenu, tako da početak sezone kupanja može ranije početi i kasnije završiti. Blokovi koriste prirodnu sunčevu svjetlost kako bi zagrijali vodu. Kvaliteta bazenskih zidova može ovisiti o mnogim čimbenicima povezanim s promjenama temperature, kao što su napetosti ili efekti smrzavanja koji mogu uzrokovati oštećenja na zidovima bazena i unutarnje folije. Za razliku od tradicionalnih materijala, sustav Porocell sprečava oštećenja i upija napetosti.

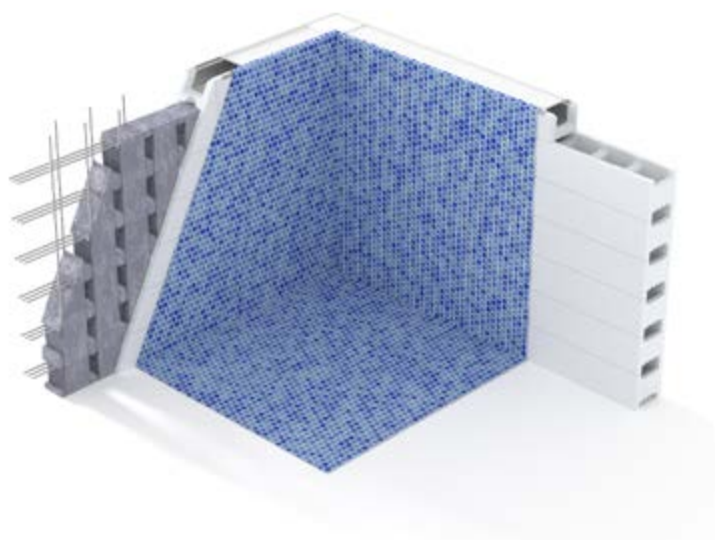

Required BIGBLOCK elements based on pool size (depth 1,5m)

L x W	3	3,5	4	4,5	5	5,5	6
5	42	44	46	48	52	54	56
5,5	44	46	48	52	54	56	58
6	46	48	52	54	56	58	60
6,5	48	52	54	56	58	60	64
7	52	54	56	58	60	64	66
7,5	54	56	58	60	64	66	68
8	56	58	60	64	66	68	70
8,5	58	60	64	66	68	70	72
9	60	64	66	68	70	72	76
9,5	64	66	68	70	72	76	78
10	66	68	70	72	76	78	80
10,5	68	70	72	76	78	80	82
11	70	72	76	78	80	82	84
11,5	72	76	78	80	82	84	88
12	76	78	80	82	84	88	90

BIGBLOCK EPS30 - EPS40

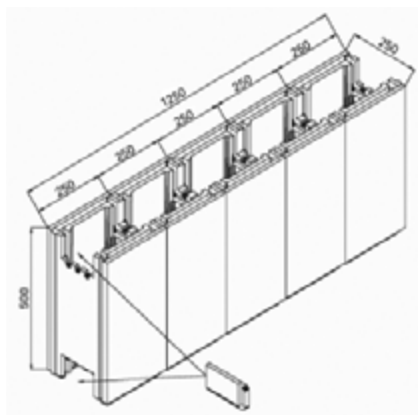

Code	Description	PKG	WGT
181013	F Porocell BigBlock EPS30 1,250 x 500 x 250mm	24	2,2
181113	F Porocell BigBlock EPS40 1,250 x 500 x 250mm	24	
181014	F Porocell Big RoundBlock EPS30 1,250 x 500 x 250mm	24	1,9
181015	F Porocell Big EndBlock EPS30 160 x 97 x 31,5mm	144	0,02
181016	F Porocell BigBlock Arc EPS30 R = 0 m	116	0,06
181018	F Porocell BigBlock Arc EPS30 R = 1,25 m	78	0,06
181019	F Porocell BigBlock Arc EPS30 R = 1,5 m	83	0,06
181020	F Porocell BigBlock Arc EPS30 R = 1,75 m	88	0,06
181021	F Porocell BigBlock Arc EPS30 R = 2 m	88	0,06
181022	F Porocell BigBlock Arc EPS30 R = 2,5 m	98	0,06
181023	F Porocell BigBlock Arc EPS30 R = 3 m	98	0,06
181024	F Porocell BigBlock Arc EPS30 R = 3,5 m	98	0,06
181025	F Porocell BigBlock Arc EPS30 R = 5 m	103	0,06
181026	F Porocell BigBlock Arc EPS30 R = 7 m	103	0,06
181030	F Porocell BigBlock overflow channel EPS100 1,010 x 170 x 270mm		
181031	F Porocell BigBlock overflow channel corner EPS100 1,030 x 170 x 280mm		



ECOBLOCK EPS30 - EPS40

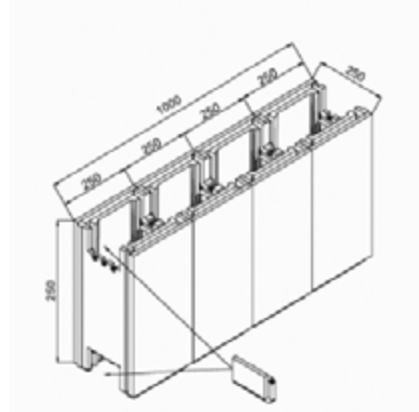

Code	Description	PKG	WGT
181000	F Porocell EcoBlock EPS30 1,000 x 250 x 250mm	58	
181100	F Porocell EcoBlock EPS30 1,000 x 250 x 250mm	58	
181001	F Porocell Eco RoundBlock EPS30 1,000 x 250 x 250mm	509	
181002	F Porocell Eco EndBlock EPS30 160 x 88 x 45mm	280	
181003	F Porocell Eco Arc Block EPS30 R = 0 m	178	
181004	F Porocell Eco Arc Block EPS30 R = 1 m	172	
181005	F Porocell Eco Arc Block EPS30 R = 1,25 m	176	
181006	F Porocell Eco Arc Block EPS30 R = 1,5 m	198	
181007	F Porocell Eco Arc Block EPS30 R = 2 m	212	
181008	F Porocell Eco Arc Block EPS30 R = 2,5 m	220	
181009	F Porocell Eco Arc Block EPS30 R = 3 m	226	
181010	F Porocell Eco Arc Block EPS30 R = 3,5 m	278	
181011	F Porocell Eco Arc Block EPS30 R = 5 m	254	
181012	F Porocell Eco Arc Block EPS30 R = 7 m	103	2,6
181030	F Porocell BigBlock overflow channel EPS100 1,010 x 170 x 270mm		
181031	F Porocell BigBlock overflow channel corner EPS100 1,030 x 170 x 280mm		



REPLACEMENT LINERS FOR STYROPOR POOLS 0.6 MM

Size	Adria blue		Sand, gray		Blue mosaic	
	Code		Code		Code	Net. Pr.
B 3,00 x 6,00 x 1,50 m	185254		185255		-	-
B 3,50 x 7,00 x 1,50 m	185256		185257		-	-
B 4,00 x 8,00 x 1,50 m	185258		185259		-	-
B 5,00 x 9,00 x 1,50 m	185260		185261		-	-

REPLACEMENT LINERS FOR STYROPOR POOLS 0.8 MM

Size	Adria blue		Sand, gray		Blue mosaic	
	Code		Code		Code	
B 3,00 x 6,00 x 1,50 m	185610		185611		185612	
B 3,50 x 7,00 x 1,50 m	185613		185614		185615	
B 4,00 x 8,00 x 1,50 m	185616		185617		185618	
B 5,00 x 9,00 x 1,50 m	185619		185620		185621	

REPLACEMENT LINERS FOR STYROPOR POOLS 1.0 MM

Size	Adria blue		Sand, gray		Blue mosaic	
	Code		Code	Gross Pr.	Code	Net. Pr.
B 3,00 x 6,00 x 1,50 m	185718		-	-	-	-
B 3,50 x 7,00 x 1,50 m	185719		-	-	-	-
B 4,00 x 8,00 x 1,50 m	185720		-	-	-	-
B 5,00 x 9,00 x 1,50 m	185721		-	-	-	-

Code	Description	PKG	WGT
181040	F Liner lock profil L=2,0m	24	2,2



MILANO



Adria blue

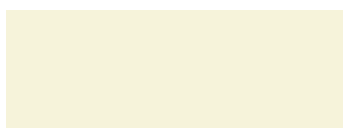

Sand



Gray

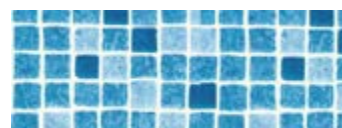

Blue mosaic

Color	Category	Liner thickness
Standard handrail basic color: Adria blue	Basic	0.6 / 0.8 mm
Style handrail colors: Adria blue, Sand, Gray	Style	0.8 mm
Blue mosaic	Price quotation	0.8 mm

Depth	Wall thickness
90 cm	0,40 mm
120 cm	0,60 mm
135 / 150 cm	0,70 mm

- Both sides of the steel-wall has protective coating and galvanized. The inner shell is made of UV-stabilized PVC liner.
- The liner can be easily fixed by the corresponding profiles
- The aluminum profile enables quick and easy setup (no screw is needed).
- Due to the blue-style, aluminum-style and the sand-style edge, the liner is easily removable under the border.

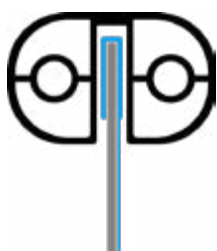

STANDARD HAND RAIL WITH P1 TYPE LINER



STYLE HAND RAIL WITH P1 OR P3*

* The STYLE hand rail's basic liner type is P1. (P3 type available upon individual design requests)

MILANO 90, LINER 0.6MM SKY BLUE

Code		Description	Net. Pr.	Gross Pr.	Net. Pr.	Gross Pr.
standard	blue-style		standard		blue-style	
183000	183001	B 2,00 x 0,90 m; 3 m ³				
183003	-	B 2,50 x 0,90 m; 5 m ³				
183004	183005	B 3,00 x 0,90 m; 6 m ³				
183007	183008	B 3,50 x 0,90 m; 8 m ³				

MILANO 120, LINER 0.6MM SKY BLUE

Code		Description	Net. Pr.	Gross Pr.	Net. Pr.	Gross Pr.
standard	blue-style		standard		blue-style	
183011	183012	B 3,00 x 1,20 m; 8 m ³				
183014	183015	B 3,50 x 1,20 m; 11 m ³				
183017	183018	B 4,16 x 1,20 m; 15 m ³				
183020	183021	B 4,50 x 1,20 m; 18 m ³				
183023	183024	B 5,00 x 1,20 m; 22 m ³				
183026	183027	B 6,00 x 1,20 m; 31 m ³				

MILANO 135, LINER 0.6MM SKY BLUE

Code		Description	Net. Pr.	Gross Pr.	Net. Pr.	Gross Pr.
standard	blue-style		standard		blue-style	
183035	183036	B 3,50 x 1,35 m; 13 m ³				
183038	183039	B 4,50 x 1,35 m; 21 m ³				
183041	183042	B 5,00 x 1,35 m; 25 m ³				
183044	183045	B 6,00 x 1,35 m; 36 m ³				

MILANO 150, LINER 0.6MM SKY BLUE

Code		Description	Net. Pr.	Gross Pr.	Net. Pr.	Gross Pr.
standard	blue-style		standard		blue-style	
183050	183051	B 4,16 x 1,50 m; 19 m ³				
183053	183054	B 4,50 x 1,50 m; 23 m ³				
183056	183057	B 5,00 x 1,50 m; 28 m ³				
183059	183060	B 6,00 x 1,50 m; 40 m ³				
183062	183063	B 7,00 x 1,50 m; 58 m ³				

MILANO 120, LINER 0.8MM SKY BLUE

Code		Description	Net. Pr.	Gross Pr.	Net. Pr.	Gross Pr.
standard	blue-style		standard		blue-style	
183074	183075	B 4,16 x 1,20 m; 15 m ³				
183077	183078	B 4,50 x 1,20 m; 18 m ³				
183080	183081	B 5,00 x 1,20 m; 22 m ³				
183083	183084	B 6,00 x 1,20 m; 31 m ³				

MILANO 135, LINER 0.8MM SKY BLUE

Code		Description	Net. Pr.	Gross Pr.	Net. Pr.	Gross Pr.
standard	blue-style		standard		blue-style	
183095	183096	B 4,50 x 1,35 m; 21 m ³				
183098	183099	B 5,00 x 1,35 m; 25 m ³				
183101	183102	B 6,00 x 1,35 m; 36 m ³				

MILANO 150, LINER 0.8MM SKY BLUE

Code		Description	Net. Pr.	Gross Pr.	Net. Pr.	Gross Pr.
standard	blue-style		standard		blue-style	
183107	183108	B 4,16 x 1,50 m; 19 m ³				
183110	183111	B 4,50 x 1,50 m; 23 m ³				
183113	183114	B 5,00 x 1,50 m; 28 m ³				
183116	183117	B 6,00 x 1,50 m; 40 m ³				



REPLACEMENT LINERS FOR ROUND POOLS

	Size	Code	0.6 mm		0.8 mm		
			Net. Pr.	Gross Pr.	Code	Net. Pr.	Gross Pr.
B	ø 2,00 x 0,90 m	185000			-	-	-
B	ø 3,00 x 0,90 m	185004			-	-	-
B	ø 3,50 x 0,90 m	185008			-	-	-
B	ø 3,00 x 1,20 m	185012			185262		
B	ø 3,20 x 1,20 m	185016			-		-
B	ø 3,50 x 1,20 m	185020			185268		
B	ø 4,00 x 1,20 m	185024			185274		
B	ø 4,16 x 1,20 m	185028			185280		
B	ø 4,20 x 1,20 m	185032			185286		
B	ø 4,50 x 1,20 m	185036			185292		
B	ø 5,00 x 1,20 m	185040			185298		
B	ø 5,50 x 1,20 m	185044			185304		
B	ø 6,00 x 1,20 m	185048			185310		
B	ø 7,00 x 1,20 m	185052			185316		
B	ø 8,00 x 1,20 m	-		-	185322		
B	ø 3,50 x 1,35 m	185060			185328		
B	ø 4,50 x 1,35 m	185064			185334		
B	ø 5,00 x 1,35 m	185068			185340		
B	ø 6,00 x 1,35 m	185072			185346		
B	ø 3,00 x 1,50 m	185076			185352		
B	ø 3,20 x 1,50 m	185080			-		-
B	ø 3,50 x 1,50 m	185084			185358		
B	ø 4,00 x 1,50 m	185088			185364		
B	ø 4,16 x 1,50 m	185092			185370		
B	ø 4,20 x 1,50 m	185096			185376		
B	ø 4,50 x 1,50 m	185100			185382		
B	ø 5,00 x 1,50 m	185104			185388		
B	ø 5,50 x 1,50 m	185108			185394		
B	ø 6,00 x 1,50 m	185112			185400		
B	ø 7,00 x 1,50 m	185116			185406		
B	ø 8,00 x 1,50 m	185120			185412		

* The STYLE hand rail's basic liner type is P1. (P3 type available upon individual design requests)

TOSCANA



Adria blue

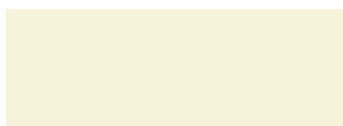

Sand



Gray

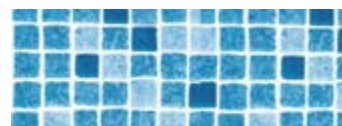

Blue mosaic

Color	Category	Liner thickness
Standard handrail basic color: Adria blue	Basic	0.6 / 0.8 mm
Style handrail colors: Adria blue, sand, gray	Style	0.8 mm
Blue mosaic	Price quotation	0.8 mm

Depth	Wall thickness
90 cm	0,40 mm
120 cm	0,60 mm
135 / 150 cm	0,70 mm

- Both sides of the steel-wall has protective coating and galvanized. The inner shell is made of UV-stabilized PVC liner.
- The liner can be easily fixed by the corresponding profiles
- The aluminum profile enables quick and easy setup (no screw is needed).
- Due to the blue-style, aluminum-style and the sand-style edge, the liner is easily removable under the border.

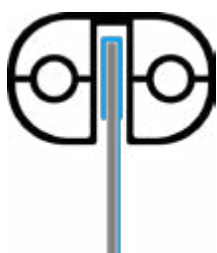

STANDARD HAND RAIL WITH P1 TYPE LINER



STYLE HAND RAIL WITH P1 OR P3*

* The STYLE hand rail's basic liner type is P1.(P3 type available upon individual design requests)

TOSCANA 120, LINER 0.6MM SKY BLUE

Code		Description	Net. Pr.	Gross Pr.	Net. Pr.	Gross Pr.
standard	blue-style		standard		blue-style	
184200	-	B 3,00 X 4,90 X 1,20 m; 12 m ³			-	-
184000	184001	B 3,20 X 5,25 X 1,20 m; 17 m ³				
184003	184004	B 3,20 X 6,00 X 1,20 m; 19 m ³				
184006	184007	B 3,50 X 7,00 X 1,20 m; 24 m ³				
184009	184010	B 4,16 X 8,00 X 1,20 m; 33 m ³				
184012	184013	B 4,16 X 10,00 X 1,20 m; 42 m ³				
184015	184016	B 5,00 X 9,00 X 1,20 m; 44 m ³				
184018	184019	B 5,00 X 11,00 X 1,20 m; 55 m ³				

TOSCANA 135, LINER 0.6MM SKY BLUE

Code		Description	Net. Pr.	Gross Pr.	Net. Pr.	Gross Pr.
standard	blue-style		standard		blue-style	
184021	184022	B 3,20 X 5,25 X 1,35 m; 20 m ³				
184024	184025	B 3,20 X 6,00 X 1,35 m; 22 m ³				
184027	184028	B 3,50 X 7,00 X 1,35 m; 28 m ³				
184030	184031	B 4,16 X 8,00 X 1,35 m; 37 m ³				

TOSCANA 150, LINER 0.6MM SKY BLUE

Code		Description	Net. Pr.	Gross Pr.	Net. Pr.	Gross Pr.
standard	blue-style		standard		blue-style	
184033	184034	B 3,20 X 5,25 X 1,50 m; 22 m ³				
184036	184037	B 3,20 X 6,00 X 1,50 m; 24 m ³				
184039	184040	B 3,50 X 7,00 X 1,50 m; 31 m ³				
184042	184043	B 4,16 X 8,00 X 1,50 m; 41 m ³				
184045	184046	B 4,16 X 10,00 X 1,50 m; 53 m ³				
184048	184049	B 5,00 X 9,00 X 1,50 m; 56 m ³				
184051	184052	B 5,00 X 11,00 X 1,50 m; 70 m ³				



TOSCANA 120, LINER 0.8MM SKY BLUE

Code		Description	Net. Pr.	Gross Pr.	Net. Pr.	Gross Pr.
standard	blue-style		standard		blue-style	
184054	184055	B 3,20 X 5,25 X 1,20 m; 17 m ³				
184057	184058	B 3,20 X 6,00 X 1,20 m; 19 m ³				
184060	184061	B 3,50 X 7,00 X 1,20 m; 24 m ³				
184063	184064	B 4,16 X 8,00 X 1,20 m; 33 m ³				
184066	184067	B 4,16 X 10,00 X 1,20 m; 42 m ³				
184069	184070	B 5,00 X 9,00 X 1,20 m; 44 m ³				
184072	184073	B 5,00 X 11,00 X 1,20 m; 55 m ³				

TOSCANA 135, LINER 0.8MM SKY BLUE

Code		Description	Net. Pr.	Gross Pr.	Net. Pr.	Gross Pr.
standard	blue-style		standard		blue-style	
184075	184076	B 3,20 X 5,25 X 1,35 m; 20 m ³				
184078	184079	B 3,20 X 6,00 X 1,35 m; 22 m ³				
184081	184082	B 3,50 X 7,00 X 1,35 m; 28 m ³				
184084	184085	B 4,16 X 8,00 X 1,35 m; 37 m ³				

TOSCANA 150, LINER 0.8MM SKY BLUE

Code		Description	Net. Pr.	Gross Pr.	Net. Pr.	Gross Pr.
standard	blue-style		standard		blue-style	
184087	184088	B 3,20 X 5,25 X 1,50 m; 22 m ³				
184090	184091	B 3,20 X 6,00 X 1,50 m; 24 m ³				
184093	184094	B 3,50 X 7,00 X 1,50 m; 31 m ³				
184096	184097	B 4,16 X 8,00 X 1,50 m; 41 m ³				
184099	184100	B 4,16 X 10,00 X 1,50 m; 53 m ³				
184102	184103	B 5,00 X 9,00 X 1,50 m; 56 m ³				
184105	184106	B 5,00 X 11,00 X 1,50 m; 70 m ³				



REPLACEMENT LINERS FOR OVAL POOLS

Size	0.6 mm			0.8 mm		
	Code	Net. Pr.	Gross Pr.	Code	Net. Pr.	Gross Pr.
B 3,00 x 4,90 x 1,20 m	185124			185418		
B 3,00 x 5,00 x 1,20 m	185128			185424		
B 3,00 x 7,00 x 1,20 m	185132			185430		
B 3,20 x 5,25 x 1,20 m	185138			185436		
B 3,20 x 6,00 x 1,20 m	185142			185442		
B 3,50 x 7,00 x 1,20 m	185146			185448		
B 3,60 x 6,23 x 1,20 m	185150			185454		
B 3,60 x 7,37 x 1,20 m	185154			185460		
B 4,00 x 8,00 x 1,20 m	185158			185466		
B 4,16 x 8,00 x 1,20 m	185162			185472		
B 4,00 x 10,00 x 1,20 m	185166			185478		
B 4,16 x 10,00 x 1,20 m	185170			185484		
B 5,00 x 9,00 x 1,20 m	185174			185490		
B 5,00 x 11,00 x 1,20 m	185178			185496		
B 3,20 x 5,25 x 1,35 m	185182			185502		
B 3,20 x 6,00 x 1,35 m	185186			185508		
B 3,50 x 7,00 x 1,35 m	185190			185514		
B 4,16 x 8,00 x 1,35 m	185194			185520		
B 3,00 x 4,90 x 1,50 m	185198			185526		
B 3,00 x 5,00 x 1,50 m	185202			185532		
B 3,00 x 7,00 x 1,50 m	185206			185538		
B 3,20 x 5,25 x 1,50 m	185210			185544		
B 3,20 x 6,00 x 1,50 m	185214			185550		
B 3,50 x 7,00 x 1,50 m	185218			185556		
B 3,60 x 6,23 x 1,50 m	185222			185562		
B 3,60 x 7,37 x 1,50 m	185226			185568		
B 4,00 x 8,00 x 1,50 m	185230			185574		
B 4,16 x 8,00 x 1,50 m	185234			185580		
B 4,00 x 10,00 x 1,50 m	185238			185586		
B 4,16 x 10,00 x 1,50 m	-		-	185592		
B 5,00 x 9,00 x 1,50 m	185246			-		-
B 5,00 x 11,00 x 1,50 m	-		-	185604		

* The STYLE hand rail's basic liner type is P1. (P3 type available upon individual design requests)