

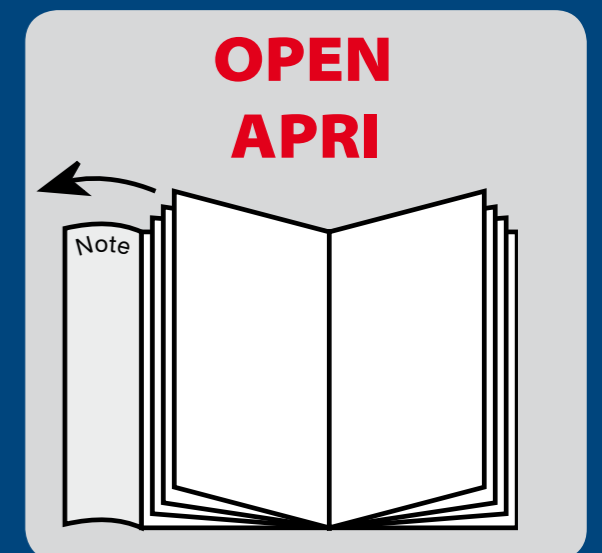

Let's all work
Together for
Everyone's safety!



PRICE-LIST FOR SPRAYING AND GARDENING PUMPS





NOTE

- ① - Mass-produced safety valve and cardan protection -
 - ② - Mass-produced safety valve
 - ③ **WARNING!** Use this application only with the opportune protections for user defence. -
 - ④ - Important: When ordering specify pump flow rate -
 - ⑤ - Anodized pump
 - ⑥ - For gas engines and electric motors only
 - ⑦ - Without the safety valve
 - ⑧ **Version C** (Integral shaft 1"3/8)
 - ⑨ - Upon request safety valve kit
 - ⑩ - Built-in recoil
 - ⑪ - Mass-produced cardan protection
 - ⑫ - Motor base only.
 - ⑬ - Price for base or frame see pages 36÷37
 - ⑭ - With electric start standard
 - ⑮ Supplement for electric starting and panel for 4-stroke engines
- | | | | | | |
|-----------------|---------------|----------|-------|----------|----------|
| Lombardini | 15LD 350 | € 776,00 | Honda | GX 160 | € 460,00 |
| | 15LD 500 | € 855,00 | | GX 270 | € 480,00 |
| Briggs&Stratton | 185432/196432 | € 341,00 | | GX 340 | € 497,00 |
| | 245432 | € 376,00 | | GX 390 | € 497,00 |
| | 123432 | € 320,00 | Kama | K365D2 | € 210,00 |
| | | | Axo | AMG200F1 | € 210,00 |
- ⑯ - Overprice for switch and cable (without plug) for 2 - 2,5 - 3 - 4 - 5,5 - 7,5 HP
 - HP 2 - 2,5 - 3 EM € 40,00
 - HP 2,5 - 3 - 4 ET € 48,00
 - HP 5,5 - 7,5 - 8,5 ET € 55,00
 - ⑰ - Overprice 5% overprice for AR DUE with 60Hz electric motors
 - ⑱ - See codes and prices page 29 for hydraulic motor applications
 - ⑲ - See codes and prices page 29 for hydraulic pump applications
 - ⑳ - See codes and prices for agricultural machines applications at pages 38÷55
 - ㉑ - See codes and prices of flanges for BIMA, COMER, FIENI, GB and REDUCO overgears at page 28
 - ㉒ - See codes and prices page 28 for BIMA, COMER, FIENI, GB and REDUCO overgear applications
 - ㉓ With base
 - ㉔ - With switch, cable and plug
 - ㉕ - Pump and reduction gear for CM46, DUCATISALICE, FAMOSA H60, OLEOMAC 50 and VIBI MASTER 50 series
 - ㉖ - Engine without fuel tank
 - ㉗ } - Surcharge for special flange requirements
 - ㉘ } - Surcharge for special flange requirements

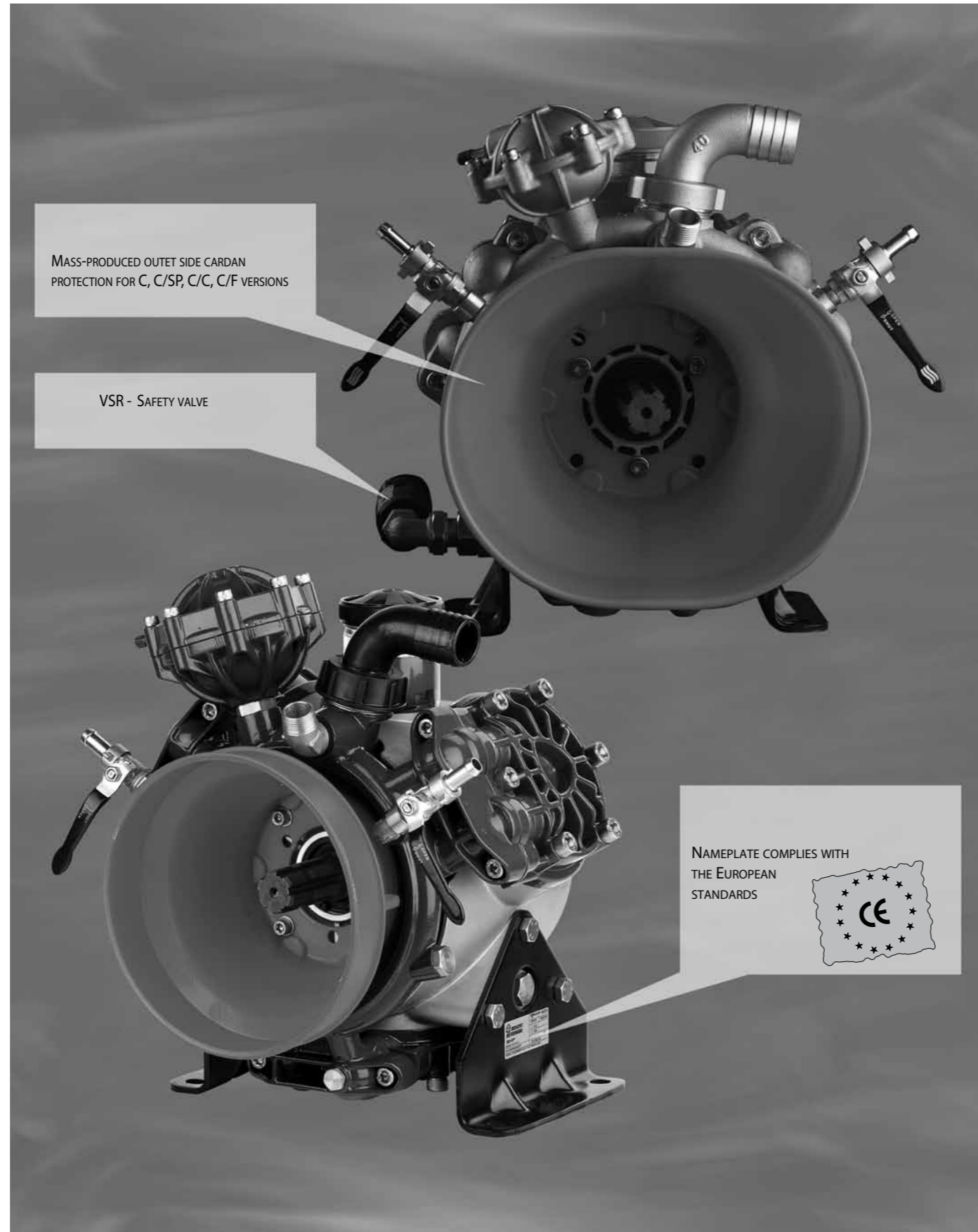

Price-list pump with control unit and fitting for agricultural machines (5...) = Code for flange only

MARCA	Tipo	APPLICAZIONE	AR 202 (VRI)	AR 252 (GR 30)	AR 30 (GI 40)	AR 303 (GR 40)	AR 403 (GR 40)	AR 50 (GI 40)	AR 503 (RM 40)		
YAĞMUR	Elmas 80 - Safir 120 - Zumurut 70	○	-	-	452,80 (5256)	438,80 (5256)	445,80 (5256)	561,80 (5256)	529,80 (5256)		
	Elmas 80 - Safir 120 - Zumurut 70 (attacco rapido)	○	-	-	440,30 (5300)	426,30 (5300)	433,30 (5300)	549,30 (5300)	517,30 (5300)		
	Inci 50 Reversibile (attacco rapido)	○	-	-	292,00 (55361)	331,30 (55361)	440,30 (5299)	426,30 (5299)	433,30 (5299)	549,30 (5299)	517,30 (5299)
	Yakut 150	○	-	-	452,80 (5252)	438,80 (5252)	445,80 (5252)	561,80 (5252)	529,80 (5252)		

□◆●○ / Surcharge for special flange requirements /

This Price-List cancels and replaces all previous ones and is subject to modification without notice. Data, description, photographs and illustrations are purely guideline and are not binding. Annovi Riverberi S.p.A. preserves the right to make partial shipments.

Price list (€) for spraying and gardening pumps



ANNOVI[®]
REVERBERI
The Power of Experience





Index of versions	PAG.	5 ÷ 8
Prices and codes for plastic-coated low pressure spraying diaphragm pumps	PAG.	10 ÷ 12
AR 115 bp/1000 - AR 45 bp - AR 70 bp - AR 115 bp - AR 135 bp - AR 125 bp - AR 145 bp - AR 160 bp - AR 185 bp - AR 215 bp - AR 250 bp - AR 280 bp AR 330 bp - AR 410 bp - AR 460 bp - AR 320 bp TWIN - AR 370 bp TWIN - AR 500/bp TWIN - AR 560/bp TWIN		
Prices and codes of remote control units for low pressure pumps	PAG.	13
ECM - UCM - IDROMINUS - IDROCOSTANT M - GS 25 S - GS 20 S - RM 20 S - VDR 20 S		
Prices and codes for anodized and plastic-coated medium pressure diaphragm pumps	PAG.	14
AR DUE - AR 202 - AR 252 - AR 30 - AR 50		
Prices and codes of control units for medium and high pressure pumps	PAG.	15,17,19,21,23
VR 20 S - GR 20 S - GI 30 - GI 40 - GR 30 - GR 40 - RM 40 - VDR 50 - GH 50 - VH 50 - BY MATIC 50 - BMH 50 - BMS 50		
Prices and codes for anodized medium and high pressure diaphragm pumps	PAG.	16, 18
AR 303 - AR 403 - AR 503 - AR 713 - AR 813 - AR 903 - AR 1053 - AR 1064 - AR 1203		
Prices and codes for high pressure diaphragm pumps with external manifolds and heads in anodized or plastic-coated aluminium.	PAG.	20
BHA 130 - BHA 150 - BHA 170 - BHA 200 - BHP 130 - BHP 150 - BHP 170 - BHP 200		
Prices and codes for high pressure diaphragm pumps with external bronze manifolds and brass heads	PAG.	22
BHS 90 - BHS 105 - BHS 120 - BHS 130 - BHS 150 - BHS 170 - BHS 200		
Prices and codes high pressure pistons pumps HYD-XJS 11.14 / HYD-XM 15.15 / HYD-RK 15.20 / HYD-XW 30.10	PAG.	25
Prices and codes of gear units for electric motors, petrol engines and agricultural machinery	PAG.	26, 27
Prices and codes pump applications for overgears on air-blast sprayers - FD	PAG.	28
Prices and codes pump applications for overgears on air-blast sprayers - FDG	PAG.	28
Prices and codes of pump applications for hydraulic motors - IDM	PAG.	29
Prices and codes of pump applications for hydraulic pumps - IDP	PAG.	29
OPTIONAL	PAG.	30, 31
Prices and codes for motor-driven pump and electric pump assemblies	PAG.	32 ÷ 35
Prices and codes for bases, frames, trolleys, wheelbarrows, hose reels and accessories	PAG.	36, 37
Prices and codes of flanges for agricultural machinery - FM/FT	PAG.	38 ÷ 55



VRI
Built- in regulating valve



S.G.C.
Without control unit



SP
Pump only with base

C
Universal shaft 1"3/8

CR
With gearbox

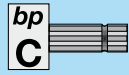

CRxS
Model with 1:5, 9 reduction gear for four-stroke engines



S
Flanged to petrol engine



SD
Flanged to diesel engine



DC
Coupled to D.C. electric motor



EM
Flanged to single-phase electric motor



ET
Flanged to three-phase electric motor

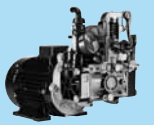

C.A.
Air chamber





SP
Pump only



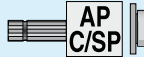

AP
Through shaft

C/SP - 1"3/8 M
Universal shaft 1"3/8 M - Pump only

C/C - 1"3/8 M / 1"3/8 M
Universal shaft 1"3/8 M - Universal shaft 1"3/8 M

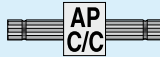
C/F - 1"3/8 M / 1"3/8 F
Universal shaft 1"3/8 M - Female 1"3/8



Per Multiplicatori



C/F 1"3/8 M / Ø 25, Ø 32 F cilindrico
Universal shaft 1"3/8 M - Female Ø 25, Ø 32



Per Motori Idraulici



Application kit

C
Universal shaft 1"3/8



F
Female 1"3/8



P
Pulley



T
Quick coupling for standardized tractor PTO



FT ⑳
Flange for tractors



FM ⑳
Flanged for motor- cultivators, motor-hoes



FD ㉑
Flange for BIMA, COMER, FIENI and GB overgears



FDG ㉑
Flange for BIMA, COMER, FIENI and GB overgears



IDM ㉒
Flanged for hydraulic motors



IDP ㉓
Flange for hydraulic pumps





Pumps and control units basic versions

Plastic-coated low pressure spraying diaphragm pumps with GEOMET nuts and bolts

Type	N° of diaph.	Delivery		Pressure		Power HP	RPM	Weight kg	Suction mm	Outlet	Air Chamber
		L/1'	gpm	bar	psi						
NEW AR 45 bp	3	43,3	11,4	20	290	2,1	550	11	ø 35	ø 25	-
AR 70 bp	2	74,1	19,6	20	290	3,4	550	11,8	ø 30	ø 25	●
AR 115 bp	3	107,9	28,5	20	290	5,5	550	15,5	ø 40	ø 25	●
AR 135 bp	3	128	33,8	20	290	6,8	550	15,5	ø 40	ø 25	●
AR 115 bp/1000	3	94	25,4	15	220	4,2	1000	15,5	ø 40	ø 25	●
AR 125 bp	3	120,4	31,8	20	290	5,8	550	23	ø 40	ø 25	●
AR 145 bp	3	133	35,1	20	290	6,3	550	23	ø 40	ø 25	●
AR 160 bp	4	166,2	43,9	20	290	8,4	550	27,5	ø 40	ø 25	●
AR 185 bp	4	182,1	48,1	20	290	9,3	550	27,5	ø 50	ø 35	●
AR 215 bp	6	219,1	57,9	20	290	9,9	550	38,5	ø 50	ø 35	●
AR 250 bp	6	254,4	67,2	20	290	11,4	550	38,5	ø 50	ø 35	●
AR 280 bp	6	277,8	73,4	20	290	12,9	550	38,5	ø 60	ø 35	●
NEW AR 330 bp	4	318,8	84,2	20	290	15,4	550	60	ø 60	ø 35	●
AR 410 bp	6	401,2	106	20	290	19,4	550	78,5	ø 75	ø 40	●
AR 460 bp	6	450,3	119	20	290	22,4	550	78,5	ø 75	ø 40	●
AR 320 bp Twin	8	321,2	84,9	20	290	16,8	550	58	ø 60	2 x ø 35	2 x ●
AR 370 bp Twin	8	371,5	98,2	20	290	17,3	550	58	ø 60	2 x ø 35	2 x ●
AR 500 bp Twin	12	489,4	129,3	20	290	23,6	550	75	2 x ø 50	2 x ø 35	2 x ●
AR 560 bp Twin	12	543,2	143,5	20	290	26,6	550	75	2 x ø 60	2 x ø 35	2 x ●

● = Supplied as standard

Anodized and plastic-coated medium pressure diaphragm pumps for gardening

Type	N° of diaph.	Delivery		Pressure		Power HP	RPM	Weight kg	Suction mm	Outlet	V.R.I	Air Chamber
		L/1'	gpm	bar	psi							
AR DUE	2	13	3,5	20	290	0,6	1450	2,1	Ø 20	2 x Ø 8	●	●
AR 202	2	23,2	6,1	20	290	1,02	650	4	Ø 20	2 x Ø 8	●	●
AR 252	2	24,6	6,5	25	362	1,42	650	4	Ø 20	Ø 13	◆	●
AR 30	2	36,2	9,6	40	580	2,9	550	9,3	Ø 25	Ø 13	◆	●
AR 50	2	65,8	17,4	40	580	5,2	550	16	Ø 30	Ø 13	◆	●

◆ = Supplied as separate item
● = Supplied as standard

Anodized medium and high pressure diaphragm pumps

Type	N° of diaph.	Delivery		Pressure		Power HP	RPM	Weight kg	Suction mm	Outlet	Valves N° / mm	Air Chamber
		L/1'	gpm	bar	psi							
AR 303	3	34,7	9,2	40	580	3	550	9	Ø 25	Ø 13	-	-
AR 403	3	40,7	10,7	40	580	3,6	550	9	Ø 25	Ø 13	-	-
AR 503	3	54,1	14,3	40	580	5,6	550	11,5	Ø 30	Ø ¾"G(M)	-	-
AR 713	3	76,1	20,1	40	580	7,3	550	20,5	Ø 40	Ø ¾"G(M)	1 x ø10	●
AR 813	3	79,9	21,1	50	725	8,8	550	20,5	Ø 40	Ø ¾"G(M)	1 x ø10	●
AR1064	4	108,5	28,7	50	725	13,1	550	23,5	Ø 40	Ø ¾"G(M)	2 x ø10	●

● = Supplied as standard



Pumps and control units basic versions

Anodized high pressure diaphragm pumps

Type	N° of diaph.	Delivery		Pressure		Power HP	RPM	Weight kg	Suction mm	Outlet	Valves N° / mm	Air Chamber
		L/1'	gpm	bar	psi							
AR 903	3	91,9	24,3	50	725	9,1	550	30,8	Ø 40	Ø ¾"G(M)	2 x ø10	●
AR 1053	3	102,4	27,0	50	725	12,1	550	31,2	Ø 40	Ø ¾"G(M)	2 x ø10	●
AR 1203	3	115,8	30,6	50	725	13,6	550	31,2	Ø 40	Ø ¾"G(M)	2 x ø10	●

● Supplied as standard

Anodized high pressure diaphragm pumps

Type	N° of diaph.	Delivery		Pressure		Power HP	RPM	Weight kg	Suction mm	Outlet	Valves N° / mm	Air Chamber
		L/1'	gpm	bar	psi							
BHA 130	3	127,5	33,7	50	725	14,4	550	40	Ø 40	Ø ¾"G(M)	2 x ø13	●
BHA 150	3	142,6	37,7	50	725	17,1	550	40	Ø 40	Ø ¾"G(M)	2 x ø13	●
BHA 170	4	160,4	42,4	50	725	19,3	550	51	Ø 40	Ø ¾"G(M)	2 x ø13	●
BHA 200	4	193,7	51,2	50	725	22,1	550	51	Ø 40	Ø ¾"G(M)	2 x ø13	●

● =Supplied as standard

Plastic-coated high pressure diaphragm pumps

Type	N° of diaph.	Delivery		Pressure		Power HP	RPM	Weight kg	Suction mm	Outlet	Valves N° / mm	Air Chamber
		L/1'	gpm	bar	psi							
BHP 130	3	127,5	33,7	50	725	14,5	550	40	Ø 40	Ø ¾"G(M)	2 x ø13	●
BHP 150	3	142,6	37,7	50	725	16,3	550	40	Ø 40	Ø ¾"G(M)	2 x ø13	●
BHP 170	4	160,4	42,4	50	725	19,3	550	51	Ø 40	Ø ¾"G(M)	2 x ø13	●
BHP 200	4	193,7	51,2	50	725	22,1	550	51	Ø 40	Ø ¾"G(M)	2 x ø13	●

● = Supplied as standard

High pressure diaphragm pumps with external bronze manifolds and brass heads

Type	N° of diaph.	Delivery		Pressure		Power HP	RPM	Weight kg	Suction mm	Outlet	Valves N° / mm	Air Chamber
		L/1'	gpm	bar	psi							
BHS 90	3	90,6	23,9	50	725	10,5	550	42,8	Ø 40	Ø ¾"G(M)	2 x ø13	●
BHS 105	3	101,9	26,9	50	725	12,0	550	42,8	Ø 40	Ø ¾"G(M)	2 x ø13	●
BHS 120	3	113,0	29,8	50	725	13,3	550	42,8	Ø 40	Ø ¾"G(M)	2 x ø13	●
BHS 130	3	127,5	33,7	50	725	14,5	550	52	Ø 40	Ø ¾"G(M)	2 x ø13	●
BHS 150	3	142,6	37,7	50	725	16,3	550	52	Ø 40	Ø ¾"G(M)	2 x ø13	●
BHS 170	4	160,4	42,4	50	725	19,3	550	65	Ø 40	Ø ¾"G(M)	2 x ø13	●
BHS 200	4	193,7	51,2	50	725	22,1	550	65	Ø 40	Ø ¾"G(M)	2 x ø13	●

● = Supplied as standard



Pumps and control units basic versions

High pressure pistons pumps c/w hydraulic engine for self-propelled machines' cleaning

Type	N° PISTON	Delivery		Pressure		Power HP	R.P.M.	Weight kg
		L/min	gpm	bar	psi			
HYD-XJS 11.14	3	11	2.90	140	2000	4	2800	13
HYD-XM 15.15	3	15	3.96	150	2200	5.5	1450	17
HYD-RK 15.20	3	15	3.96	200	2900	7.5	1450	19
HYD-XW 30.10	3	30	7.92	100	1450	7.5	1450	26

Remote control units for low pressure pumps

Type	Max flow L/min gpm	Max pressure bar psi	Inlet Ø mm	Return Ø mm	Outlet Ø mm	Valves N°
ECM	160 42.3	20 290	25	25	12 (10/20 Opt)	2-4-6
UCM	160 42.3	20 290	25	25	12 (10/20 Opt)	2-4-6
IDROMINUS	160 42.3	20 290	25	25	12 (10/20 Opt)	4-5-6
IDROCOSTANT - M	280 74	20 290	35	35	12 (10/20 Opt)	4-5-6 7-8
GS 20 S	80 21.1	20 290	20	18	10	3
NEW GS 25 S	50 13.2	20 290	25	18	10	2
RM 20 S	80 21.1	20 290	25	25	10	3
VDR 20 S	130 34.3	20 290	25	25	10	4

Control units for medium and high pressure pumps

Type	Max flow L/min / gpm	Max pressure bar / psi	Inlet Ø mm	Return Ø mm	Outlet Ø mm	Valves N°
VR 20 S	25 5.7	20 290	13	16	8	1
GR 20 S	40 10.6	20 290	13	18	10	2 (+1)
GR 30	40 10.6	25 360	13	18	10	1 (+2)
GR 40	40 10.6	40 580	13	18	10	2 (+1)
GI 30	80 21.1	30 435	13	18	10	(1)
GI 40	80 21.1	40 580	13	18	10	2 (+1)
GH 50	200 52.8	50 725	3/4"G	25	13	(2)
VH 50	200 52.8	50 725	3/4" G	25	13	(2)
RM 40	80 21.1	40 580	3/4"G	18	10	2 (+1)
VDR 50	130 34.3	50 725	3/4"G	25	10	2 (+2)
BY MATIC 50 (Aluminium)	200 52.8	50 725	3/4"G	25	13	2 (+2)
BMH 50 (Aluminium/Brass)	200 52.8	50 725	3/4"G	25	13	2
BMS 50 (Brass)	200 52.8	50 725	3/4"G	25	13	2

All pumps, motor driven pumps and electric pumps comply with the machines directive 2006/42/CE.



NEW

AR 45 bp



NEW





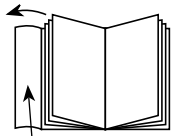







AR 330 bp





see for ① ② ③ ④ ⑬ ⑰

-Type

	Version/Code					Application kit/Code ^③					
	S.G.C.					C	T	P	IDM ⑱	IDP ⑲	FD ⑳
	 C	 SP	 C/C	 C/F 1'3/8	 SP x CR						
AR 115 bp / 1000 	540,00 (1199) ①	-	-	-	-	-	-	-	-	-	-
AR 45 bp NEW 	340,00 (1267) ⑦ ⑪	330,00 (1268) ⑦	-	-	-	-	-	62,00 (31058)	88,00 ⑱	-	-
AR 70 bp 	351,00 (1200) ①	335,00 (1201) ②	-	-	318,00 (1202) ②	30,00 (1512)	60,00 (1511)	62,00 (1514)	88,00 ⑱	-	-
AR 115 bp 	482,00 (1203) ①	465,00 (1204) ②	-	-	462,00 (1205) ②	30,00 (1512)	60,00 (1511)	62,00 (1514)	88,00 ⑱	-	-
AR 135 bp 	496,00 (1206) ①	479,00 (1207) ②	-	-	475,00 (1208) ②	30,00 (1512)	60,00 (1511)	62,00 (1514)	88,00 ⑱	-	-
AR 125 bp AP 	-	-	634,00 (1218) ①	669,00 (1220) ①	667,00 (1243) ②	-	-	361,00 (1515)	127,00 ⑱	122,00 ⑲	60,00 ⑳
AR 145 bp AP 	-	-	657,00 (1219) ①	692,00 (1221) ①	690,00 (1244) ②	-	-	361,00 (1515)	127,00 ⑱	122,00 ⑲	60,00 ⑳





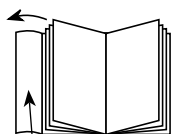











Plastic-coated low pressure spraying diaphragm pumps with air chamber and **GEOMET** nuts and bolts



see for ① ② ③ ④ ⑱ ⑲

Type





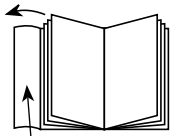



Version/Code	Application kit/Code ^③					
	S.G.C.			P	IDM ^⑱	IDP ^⑲
  C/C	  C/F Ø 25	  C/F Ø 32	 P	 IDM ^⑱	 IDP ^⑲	
AR 160 bp AP 	768,00 (1209) ①	793,00 (1233) ①	793,00 (1228) ①	361,00 (1515)	127,00 ^⑱	122,00 ^⑲
AR 185 bp AP 	790,00 (1210) ①	815,00 (1234) ①	815,00 (1229) ①	361,00 (1515)	127,00 ^⑱	122,00 ^⑲
AR 215 bp AP 	982,00 (1212) ①	-	-	361,00 (1515)	127,00 ^⑱	122,00 ^⑲
AR 250 bp AP 	1.010,00 (1211) ①	1.036,00 (1230) ①	1.036,00 (1231) ①	361,00 (1515)	127,00 ^⑱	122,00 ^⑲
AR 280 bp AP 	1.085,00 (1182) ①	1.111,00 (1235) ①	1.111,00 (1232) ①	361,00 (1515)	127,00 ^⑱	122,00 ^⑲

Signal Box, Pump Saver Kit. 30, 31)

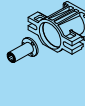
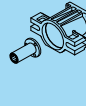

see for ① ② ③ ④ ⑬ ⑭

Type

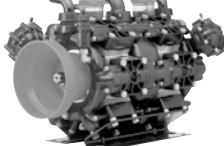





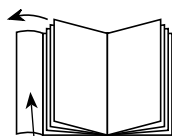











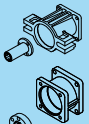
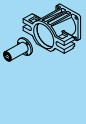

Version/Code	Kit Applications/Code ^③				
	S.G.C.		P	IDM ^⑮	IDP ^⑰
 AP C/C C/C	 AP C/F C/F Ø 32				
AR 330 bp AP 	1.340,00 (1257) ^⑦ ⑪	1.370,00 (1258) ^⑦	-	149,00 ⑮	122,00 ⑰
	1.390,00 (1259 inox) ^⑦ ⑪	1.420,00 (1260 inox) ^⑦			
AR 410 bp AP 	2.000,00 (1245) ^⑦ ⑪	2.030,00 (1246) ^⑦	-	149,00 ⑮	122,00 ⑰
	2.120,00 (1249 inox) ^⑦ ⑪	2.150,00 (1250 inox) ^⑦			
AR 460 bp AP 	2.050,00 (1247) ^⑦ ⑪	2.080,00 (1248) ^⑦	-	149,00 ⑮	122,00 ⑰
	2.170,00 (1251 inox) ^⑦ ⑪	2.200,00 (1252 inox) ^⑦			
AR 320 bp TWIN AP 	1.658,00 (1186) ^①	1.689,00 (1236) ^①	361,00 (1515)	-	-
AR 370 bp TWIN AP 	1.687,00 (1183) ^①	1.719,00 (1237) ^①	361,00 (1515)	-	-
AR 500 bp TWIN AP 	2.165,00 (1184) ^①	2.196,00 (1238) ^①	361,00 (1515)	-	-
AR 560 bp TWIN AP 	2.194,00 (1185) ^①	2.225,00 (1239) ^①	361,00 (1515)	-	-

Type	Valves	Filter	Anti drip	Code	Price	
ECM (AR 70bp÷AR 160bp)	2	-	-	(1312)	96,00	
	4	-	-	(1314)	112,00	
	6	-	-	(1316)	123,00	
	2	✓	-	(1322)	114,00	
	4	✓	-	(1324)	129,00	
	6	✓	-	(1326)	140,00	
UCM (AR 70bp÷AR 160bp)	2	-	✓	(1332)	173,00	
	4	-	✓	(1334)	187,00	
	6	-	✓	(1336)	199,00	
	2	✓	✓	(1342)	190,00	
	4	✓	✓	(1344)	204,00	
	6	✓	✓	(1346)	217,00	
IDROMINUS (AR 70bp ÷AR 160bp)	4	-	✓	(1354)	248,00	
	5	-	✓	(1355)	261,00	
	6	-	✓	(1356)	274,00	
	4	✓	✓	(1357)	267,00	
	5	✓	✓	(1358)	279,00	
	6	✓	✓	(1359)	292,00	
IDROCOSTANT - M (AR 160bp÷AR 280bp)	4	-	✓	(1384)	522,00	
	5	-	✓	(1385)	559,00	
	6	-	✓	(1386)	598,00	
	7	-	✓	(1387)	638,00	
	8	-	✓	(1388)	678,00	
NEW	GS 25 S (AR 45bp)	2	-	-	(911)	49,00
GS 20 S (AR 70bp)	3	-	-	(887)	80,00	
RM 20 S (AR 70bp÷AR 115bp)	3	-	-	(927)	98,00	
VDR 20 S (AR 70bp÷AR 135bp)	4	-	-	(954)	156,00	
IDROCOSTANT - M	- Delivery line filter			(1557)	113,00	
MANOMETRI / PRESSURE GAUGES (OPTIONAL)	bar	Ø		Code	Price	
	0 ÷ 25	100 mm		(1436)	62,00	
	0 ÷ 8 / 25	63 mm		(1439)	54,00	
	0 ÷ 6	63 mm		(1440)	14,00	

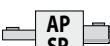
Anodized and plastic-coated medium pressure diaphragm pumps for gardening













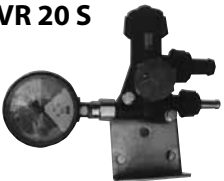
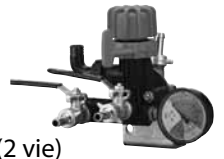

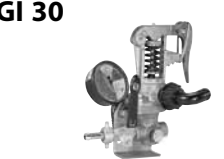

see for ① ② ③ ⑤ ⑥ ⑧ ⑨ ⑩ ⑪ ⑫

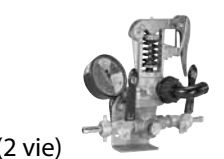
		Versions/Code				Application kit/Code ^③					
		 SP	 C/SP			- Standard shaft - 					
Type		V.R.I.	S.G.C.	S.G.C.	V.R.I.						
						C	F	P	T	FM/FT ^⑫ FDG ^⑬	IDM ^⑭ IDP ^⑮
AR DUE 		160,00 (118) ⑤	149,00 (116) ⑥	-	215,00 (123) ⑫	-	-	-	-	81,00 ⑫	-
AR 202 		211,00 (153) ⑤	200,00 (157) ⑤	-	262,00 (163) ⑫	26,00 (1488)	-	29,00 (1500)	63,00 (1499)	81,00 ⑫	75,00 ⑭
AR 252 		-	209,00 (158) ⑤	-	-	26,00 (1488)	-	29,00 (1500)	63,00 (1499)	81,00 ⑫	75,00 ⑭
AR 252 AP 		-	227,00 (159) ⑤	-	-	26,00 (1488)	-	29,00 (1500)	63,00 (1499)	81,00 ⑫	75,00 ⑭
AR 30		-	296,00 (301) ②	-	-	26,00 (1519)	27,00 (1510)	Ø 280 2A 40,00 (1504) 2A Ø 310 46,00 (1495)	66,00 (1509)	81,00 ⑫	103,00 ⑭
AR 30 AP		-	-	366,00 (335) ①	-	26,00 (1519)	27,00 (1510)	Ø 280 2A 40,00 (1504) 2A Ø 310 46,00 (1495)	66,00 (1509)	81,00 ⑫ ⑬	103,00 ⑭ ⑮
AR 50		-	405,00 (401) ②	-	-	26,00 (1519)	27,00 (1510)	Ø 310 2A 46,00 (1495) 3A Ø 310 47,00 (1520)	66,00 (1509)	81,00 ⑫	103,00 ⑭
AR 50 AP		-	-	464,00 (429) ①	-	26,00 (1519)	27,00 (1510)	Ø 310 2A 46,00 (1495) 3A Ø 310 47,00 (1520)	66,00 (1509)	81,00 ⑫ ⑬	103,00 ⑭ ⑮

^⑫ / Pump and reduction gear for CIM46, DUCATI SALICE, FAMOSA H60, OLEOMAC 50 and VIBI MASTER 50 series

Signal Box, Pump Saver Kit 30,31)

Control units with pressure gauge and kits (Code...)





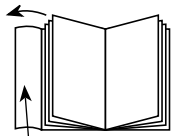









Type	Price (Code)	Kit for built-in control unit	Kits for remote control		
VR 20 S  for AR DUE AR 202 46,00 (890)		Kit VR 20 I Please see version V.R.I., at page 14	Kit VR 20 S a distanza per AR 202 S.G.C. Remote control unit with pressure gauge for AR 202 S.G.C.		
GR 20 S  for AR DUE - AR 202 AR 252 56,00 (886)		Kit GR 20 I Not available	Kit GR 20 S a distanza Remote control unit c/w pressure gauge and cocks for localized weed-killing plants.		
GR 30 (1 via)  for AR 252 38,00 (879)		Kit I GR 30 I  3,30 (891)	Kit S GR 30 S a distanza  (+1 via) AR 252 17,00 (892) Without self-locking nuts		
GI 30 (1 via)  for AR 252 57,00 (902)		Kit GI 30 I  3,30 (973)	Kit GI 30 I a distanza Not available		
GI 40 (2 vie)  Per / for AR 30 - AR 50 60,00 (900)		Kit GI 40 I  3,30 (977)	Kit GI 40 S a distanza  (+1 via) AR 30 - AR 50 20,50 (980) Without self-locking nuts		
RM 40 (2 vie)  Optional for AR 30 - AR 50 74,00 (920)		Kit RM 40 I Not available	Kit RM 40 S a distanza  (+1 via) AR 30 - AR 50 20,00 (985) Without self-locking nuts		
VDR 50 (2 vie)  Optional per / for AR 30 - AR 50 134,00 (950)		Kit VDR 50 I Not available	Kit VDR 50 S a distanza  (+1 via) AR 30 - AR 50 22,00 (991) Without self-locking nuts		
MANOMETRI / PRESSURE GAUGES (OPTIONAL)  (1436) (1437) (1439) (1440)		bar	Ø	Code	Price
		0 ÷ 25	100 mm	(1436)	62,00
		0 ÷ 15/60	63 mm	(1437)	54,00
		0 ÷ 8 / 25	63 mm	(1439)	54,00
		0 ÷ 6	63 mm	(1440)	14,00

Anodized medium pressure diaphragm pumps

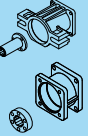





















see for ① ② ③ ⑤ ⑥ ⑧ ⑯ ⑳ ㉑

Type

Version/Code	Application kit/Code ^③							
	 		- Standard shaft - 					
	 SP	 C/SP	 C	 F	 P	 T	 FM/FT ^⑳ FDG ^㉑	 IDM ^⑱ IDP ^⑲
S.G.C.								
AR 303 	297,00 (235) ⑨	-	26,00 (1519)	27,00 (1510)	Ø 280 2A 40,00 (1504) 2A Ø 310 46,00 (1495)	66,00 (1509)	81,00 ⑳	103,00 ⑱
AR 403 	304,00 (460) ⑨	-	26,00 (1519)	27,00 (1510)	Ø 280 2A 40,00 (1504) 2A Ø 310 46,00 (1495)	66,00 (1509)	81,00 ⑳	103,00 ⑱
AR 403 AP 	-	358,00 (461) ⑨	26,00 (1519)	27,00 (1510)	Ø 280 2A 40,00 (1504) 2A Ø 310 46,00 (1495)	66,00 (1509)	81,00 ⑳ ㉑	103,00 ⑱ ⑲
AR 503 	359,00 (501) ②	-	26,00 (1519)	27,00 (1510)	Ø 310 2A 46,00 (1495) 3A Ø 310 47,00 (1520)	66,00 (1509)	81,00 ⑳	103,00 ⑱
AR 503 AP 	-	412,00 (509) ①	26,00 (1519)	27,00 (1510)	Ø 310 2A 46,00 (1495) 3A Ø 310 47,00 (1520)	66,00 (1509)	81,00 ⑳ ㉑	103,00 ⑱ ⑲

Signal Box, Pump Saver Kit.30, 31)

Control units with pressure gauge and kits (Code ...)





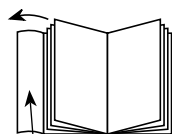

Type	Price (Code)	Kit for built-in control unit	Kits for remote control																		
GR 20 S  (2 vie)	Per / for AR 303 - AR 403 56,00 (886)	Kit GR 20 I Not available	Kit GR 20 S a distanza Remote control unit c/w pressure gauge and cocks for localized weed-killing plants.																		
		GR 40  (2 vie)	for AR 303 - AR 403 Optional for AR 503 45,00 (880)	Kit GR 40 I  3,30 (976) AR 303 - AR 403	Kit GR 40 S a distanza  (+1 via) AR 303 - AR 403 19,00 (893)  (+1 via) AR 503 21,00 (894)																
RM 40  (2 vie)	for AR 503 74,00 (920)	Kit RM 40 I  3,30 (977) AR 503	Kit RM 40 S a distanza  AR 503 18,00 (983) Without self-locking nuts  (+1 via) AR 503 24,50 (984) Without self-locking nuts  (ø 13x24) AR 503 23,00 (979) With self-locking nuts  AR 503 10,50 (928) Without self-locking nuts																		
			GI 40  (2 vie)	Optional for AR 303 - AR 403 - AR 503 60,00 (900)	Kit GI 40 I  3,30 (977) AR 303 - AR 403 Not available for AR 503	Kit GI 40 S a distanza  (+1 via) AR 303 - AR 403 20,50 (980) Senza autobloccanti Without self-locking nuts  (+1 via) AR 503 20,00 (982) Senza autobloccanti Without self-locking nuts															
						VDR 50  (2 vie)	for AR 503 134,00 (950)	Kit VDR 50 I Not available for AR 503	Kit VDR 50 a distanza  AR 503 7,20 (946) Without self-locking nuts  (+1 via) AR 503 23,50 (998) Without self-locking nuts  (ø 13x24) AR 503 28,50 (986) With self-locking nuts												
			MANOMETRI / PRESSURE GAUGES (OPTIONAL)																		
 (1436) (1437) (1439) (1440)	<table border="1"> <thead> <tr> <th>bar</th> <th>Ø</th> <th>Code</th> <th>Price</th> </tr> </thead> <tbody> <tr> <td>0 ÷ 25</td> <td>100 mm</td> <td>(1436)</td> <td>62,00</td> </tr> <tr> <td>0 ÷ 15/60</td> <td>63 mm</td> <td>(1437)</td> <td>54,00</td> </tr> <tr> <td>0 ÷ 8 / 25</td> <td>63 mm</td> <td>(1439)</td> <td>54,00</td> </tr> <tr> <td>0 ÷ 6</td> <td>63 mm</td> <td>(1440)</td> <td>14,00</td> </tr> </tbody> </table>	bar	Ø	Code	Price				0 ÷ 25	100 mm	(1436)	62,00	0 ÷ 15/60	63 mm	(1437)	54,00	0 ÷ 8 / 25	63 mm	(1439)	54,00	0 ÷ 6
bar	Ø	Code	Price																		
0 ÷ 25	100 mm	(1436)	62,00																		
0 ÷ 15/60	63 mm	(1437)	54,00																		
0 ÷ 8 / 25	63 mm	(1439)	54,00																		
0 ÷ 6	63 mm	(1440)	14,00																		

Anodized high pressure diaphragm pumps





























see for ① ② ③ ⑤ ⑥ ⑧ ⑨ ⑪ ⑫

Type

Version/Code	Application kit										③ Flange side application kit for overgears	
	Standard shaft			Standard shaft								②
	C/C	C/SP	C/F 1' - 3/8	C	F	P	T	FDG ⑫	IDM ⑮ IDP ⑯			
S.G.C.			C	F	P	T	FDG ⑫	IDM ⑮ IDP ⑯	FD ⑰			
AR 713 AP 	529,00 (625) ①	535,00 (624) ①	-	26,00 (1519)	27,00 (1510)	48,00 (1516)	66,00 (1509)	81,00 ⑫	103,00 ⑮ ⑯	-		
AR 813 AP 	545,00 (631) ①	552,00 (630) ①	561,00 (632) ①	26,00 (1519)	27,00 (1510)	48,00 (1516)	66,00 (1509)	81,00 ⑫	103,00 ⑮ ⑯	60,00 ⑰		
AR 903 AP 	639,00 (703) ①	649,00 (702) ①	661,00 (704) ①	26,00 (1519)	27,00 (1510)	47,00 (1520)	-	81,00 ⑫	103,00 ⑮ ⑯	60,00 ⑰		
AR 1053 AP 	700,00 (753) ①	711,00 (752) ①	722,00 (755) ①	26,00 (1519)	27,00 (1510)	47,00 (1520)	-	81,00 ⑫	103,00 ⑮ ⑯	60,00 ⑰		
AR 1064 AP 	610,00 (731) ①	616,00 (730) ①	626,00 (732) ①	26,00 (1519)	27,00 (1510)	47,00 (1520)	-	81,00 ⑫	103,00 ⑮ ⑯	60,00 ⑰		
AR 1203 AP 	735,00 (759) ①	745,00 (758) ①	757,00 (760) ①	26,00 (1519)	27,00 (1510)	361,00 (1515)	-	81,00 ⑫	103,00 ⑮ ⑯	60,00 ⑰		

Signal Box, Pump Saver Kit. 30, 31)

Control units with pressure gauge and kits (Code ...)

Type	Price (Code)	Kit for built-in control unit	Kits for remote control																				
RM 40  (2 vie)	Optional for AR 713 - AR 813	Kit RM 40 I  6,00 (972) AR 713 - AR 813	Kit RM 40 S a distanza  (+1 via) AR 713 - AR 813 Without self-locking nuts 24,50 (984)																				
	74,00 (920)		 (ø 13x24) AR 713 - AR 813 With self-locking nuts 23,00 (979)																				
VDR 50  (2 vie) For AR 903 - AR 1053 - AR 1203 AR 713 - AR 813 - AR 1064	134,00 (950)	Kit VDR 50 I  7,20 (946) AR 903 - AR 1053 - AR 1203	Kit VDR 50 S a distanza  AR 903 - AR 1053 - AR 1203 AR 713 - AR 813 - AR 1064 Without self-locking nuts 7,20 (946)																				
		 (+1 via) AR 903 - AR 1053 - AR 1203 AR 713 - AR 813 - AR 1064 Without self-locking nuts 23,50 (998)	 (ø 13x24) (+1 via) AR 713 - AR 813 With self-locking nuts 28,50 (986)																				
		 (ø 19x34) AR 903 - AR 1053 AR 1203 - AR 1064 With self-locking nuts 28,50 (987)																					
		Kit I  4,00 (978) AR 713 - AR 813 - AR 1064																					
BY MATIC 50  (2 vie) For AR 903 - AR 1053 - AR 1203 AR 1064	152,00 (960)	Kit I  8,00 (895) AR 903 - AR 1053 - AR 1203	Kit BY MATIC 50 S - BMH 50 S BMS 50 S a distanza  AR 903 - AR 1053 AR 1203 - AR 713 - AR 813 - AR 1064 Without self-locking nuts 2,80 (988)																				
			 AR 903 - AR 1053 AR 1203 - AR 713 - AR 813 AR 1064 Without self-locking nuts 8,00 (999)																				
BMH 50  Per / for AR 903 - AR 1053 - AR 1203 - AR 1064	170,00 (963)	Kit I  8,00 (895) AR 903 - AR 1053 - AR 1203	 (ø 19x34) AR 903 - AR 1053 AR 1203 - AR 713 - AR 813 AR 1064 With self-locking nuts 22,00 (990)																				
			Kit BY MATIC 50 S - BMH 50 S a distanza  (ø 19x34) (4 vie) AR 903 - AR 1053 - AR 1203 - AR 713 AR 813 - AR 1064 With self-locking nuts 61,00 (997)																				
BMS 50  (2 vie) NEW for AR 903 - AR 1053 - AR 1203 - AR 1064	202,00 (965)	Kit I  8,00 (895) AR 903 - AR 1053 - AR 1203																					
VH 50 For AR 903 - AR 1053 - AR 1203 - AR 713 - AR 813 AR 1064  (BRASS)	93,00 (958)	Kit I  8,00 (895) AR 903 - AR 1053 - AR 1203																					
			Compresso nel VH 50 (958)	Not available																			
GI 40 Per / for AR 713 - AR 813  (2 vie)	60,00 (900)	Kit GI 40 I Not available for AR 713 - AR 813	 AR 713 - AR 813 With self-locking nuts 20,00 (982)																				
MANOMETRI / PRESSURE GAUGES (OPTIONAL) 		<table border="1"> <thead> <tr> <th>bar</th> <th>ø</th> <th>Code</th> <th>Price</th> </tr> </thead> <tbody> <tr> <td>0 ÷ 25</td> <td>100 mm</td> <td>(1436)</td> <td>62,00</td> </tr> <tr> <td>0 ÷ 15/60</td> <td>63 mm</td> <td>(1437)</td> <td>54,00</td> </tr> <tr> <td>0 ÷ 8 / 25</td> <td>63 mm</td> <td>(1439)</td> <td>54,00</td> </tr> <tr> <td>0 ÷ 6</td> <td>63 mm</td> <td>(1440)</td> <td>14,00</td> </tr> </tbody> </table>	bar	ø	Code	Price	0 ÷ 25	100 mm	(1436)	62,00	0 ÷ 15/60	63 mm	(1437)	54,00	0 ÷ 8 / 25	63 mm	(1439)	54,00	0 ÷ 6	63 mm	(1440)	14,00	
bar	ø	Code	Price																				
0 ÷ 25	100 mm	(1436)	62,00																				
0 ÷ 15/60	63 mm	(1437)	54,00																				
0 ÷ 8 / 25	63 mm	(1439)	54,00																				
0 ÷ 6	63 mm	(1440)	14,00																				

High pressure diaphragm pumps with external manifolds and heads in anodized aluminium (BHA) and plastic-coated aluminium (BHP) (Code ...).

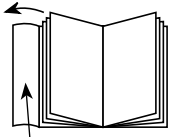

see for ① ② ③ ④ ⑤

Type

ALUMINIUM (BHA)

BHA 130 AP



BHA 150 AP



BHA 170 AP



BHA 200 AP



PLASTIC COATED (BHP)

BHP 130 AP



BHP 150 AP



BHP 170 AP

















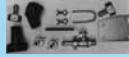



BHP 200 AP



Version/Code		Flange side application kit for overgears			
		 C/C	 C/F (1' 3/8)	 C/F Ø 32	 FD ②
S.G.C.					
		890,00 (848) ①	929,00 (849) ①	954,00 (678) ①	60,00 ②
		940,00 (850) ①	979,00 (851) ①	1.004,00 (679) ①	60,00 ②
		1.188,00 (852) ①	1.228,00 (853) ①	1.253,00 (680) ①	60,00 ②
		1.238,00 (832) ①	1.278,00 (833) ①	1.303,00 (681) ①	60,00 ②
		933,00 (854) ①	973,00 (855) ①	998,00 (682) ①	60,00 ②
		983,00 (856) ①	1.023,00 (857) ①	1.048,00 (683) ①	60,00 ②
		1.232,00 (858) ①	1.271,00 (859) ①	1.296,00 (684) ①	60,00 ②
		1.282,00 (846) ①	1.321,00 (847) ①	1.346,00 (685) ①	60,00 ②

Control units with pressure gauge and kits (Code ...)

Type	Price (Code)	Kit for built-in control unit	Kits for remote control		
GH 50  For BHA 130-150-170-200	 119,00 (962)	Compresso nel GH 50 (962)	Not available		
VH 50  For BHA 130-150-170-200	 93,00 (958)	Compresso nel VH 50 (958)	Not available		
VDR 50  (2 vie) For BHA 130 - BHS 90-105-120-130	134,00 (950)	Kit VDR 50 I  7,20 (946) BHS 90 - BHS 105 - BHS 120	Kit VDR 50 S a distanza		
			 BHA-BHS-BHP 130 Without self-locking nuts	7,20 (946)	
			 (+1 via) BHA-BHS-BHP 130 Without self-locking nuts	23,50 (998)	
			 (ø 19x34) BHA-BHS-BHP 130 With self-locking nuts	28,50 (987)	
BY MATIC 50  (2 vie) For BHA 130 - 150 - 170 - 200	 152,00 (960)	Kit I  8,00 (895) BHA-BHP 130-150-170-200 BHS 90-105-120-130-150-170-200	Kit BY MATIC 50 S - BMH 50 S - BMS 50 S a distanza		
			 AR 903-1203 BHA-BHP 130 - 150 - 170 - 200 Without self-locking nuts	2,80 (988)	
			 AR 903-1053-1203 BHA-BHP 120 - 150 - 170 - 200 Without self-locking nuts	8,00 (999)	
			 (ø 19x34) AR 903-1053-1203 BHA-BHP 120 - 150 - 170 - 200 With self-locking nuts	22,00 (990)	
BMS 50  (2 vie) for BHS 90-105-120-130-150-170-200	 202,00 (965)	8,00 (895) BHA-BHP 130-150-170-200 BHS 90-105-120-130-150-170-200	Kit BY MATIC 50 S - BMH 50 S a distanza		
			 (ø 19x34) (4 vie) AR 903-1053-1203 BHA-BHP 120 - 150 - 170 - 200 With self-locking nuts (solamente per Bymatic e BMH)	61,00 (997)	
MANOMETRI / PRESSURE GAUGES (OPTIONAL) 		bar	Ø	Code	Price
		0 ÷ 25	100 mm	(1436)	62,00
		0 ÷ 15/60	63 mm	(1437)	54,00
		0 ÷ 8 / 25	63 mm	(1439)	54,00
		0 ÷ 6	63 mm	(1440)	14,00



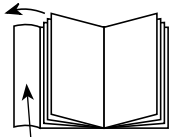

















High pressure diaphragm pumps with external bronze manifolds and brass heads



see for ① ② ③ ②① ②②























Type

BRASS (BHS)

	Version/Code				Application kit/Code ^③					Kit A
					Standard shaft 					Flange side application kit for overgears
										
S.G.C.				C	F	P	FDG ^{②①}	IDM ^⑱ IDP ^⑲	FD ^⑳	
BHS 90 AP 	1.008,00 (706) ①	1.055,00 (705) ①	1.060,00 (707) ①	-	26,00 (1519)	27,00 (1510)	47,00 (1520)	81,00 ⑳	103,00 ⑱ ⑲	60,00 ㉔
BHS 105 AP 	1.088,00 (711) ①	1.104,00 (710) ①	1.109,00 (712) ①	-	26,00 (1519)	27,00 (1510)	47,00 (1520)	81,00 ⑳	103,00 ⑱ ⑲	60,00 ㉔
BHS 120 AP 	1.128,00 (716) ①	1.143,00 (715) ①	1.149,00 (717) ①	-	26,00 (1519)	27,00 (1510)	361,00 (1515)	81,00 ⑳	103,00 ⑱ ⑲	60,00 ㉔
BHS 130 AP 	1.179,00 (761) ①	-	1.218,00 (762) ①	1.243,00 (835) ①	-	-	-	-	-	60,00 ㉔
BHS 150 AP 	1.217,00 (763) ①	-	1.257,00 (764) ①	1.282,00 (836) ①	-	-	-	-	-	60,00 ㉔
BHS 170 AP 	1.479,00 (765) ①	-	1.519,00 (770) ①	1.544,00 (837) ①	-	-	-	-	-	60,00 ㉔
BHS 200 AP 	1.515,00 (795) ①	-	1.554,00 (796) ①	1.579,00 (838) ①	-	-	-	-	-	60,00 ㉔

Signal Box, Pump Saver Kit.30, 31)

Control units with pressure gauge and kits (Code . . .)

Type	Price (Code)	Kit for built-in control unit	Kits for remote control		
GH 50  For BHS 90-105-120-130-150-170-200	119,00 (962) 	Compresso nel GH 50 (962)	Not available		
			VH 50  For BHS 90-105-120-130-150-170-200	93,00 (958) 	Compresso nel VH 50 (958)
VDR 50  (2 vie) For BHS 90-105-120-130	134,00 (950)	Kit VDR 50 I  7,20 (946) BHS 90 - BHS 105 - BHS 120	Kit VDR 50 S a distanza		
			 BHA-BHS-BHP 130 Without self-locking nuts 7,20 (946)		
			 (+1 via) BHA-BHS-BHP 130 Without self-locking nuts 23,50 (998)		
			 (ø 19x34) BHA-BHS-BHP 130 With self-locking nuts 28,50 (987)		
BY MATIC 50  (2 vie) For BHA-BHP 130 - 150 - 170 - 200	152,00 (960) 	Kit I  8,00 (895) BHA-BHP 130-150-170-200 BHS 90-105-120-130-150-170-200	Kit BY MATIC 50 S - BMH 50 S - BMS 50 S a distanza		
			 AR 903-1203 - BHS 90-105-120 BHS-BHA-BHP 130 - 150 - 170 - 200 2,80 (988) Without self-locking nuts		
			 AR 903-1053-1203 - BHS 90-105-120 BHS-BHA-BHP 130 - 150 - 170 - 200 8,00 (999) Without self-locking nuts		
BMH 50  (2 vie) For BHS 90-105-120-130-150-170-200	170,00 (963) 	8,00 (895) BHA-BHP 130-150-170-200 BHS 90-105-120-130-150-170-200	 (ø 19x34) AR 903-1053-1203 - BHS 90-105-120 BHS-BHA-BHP 120 - 150 - 170 - 200 22,00 (990) Con autobloccanti With self-locking nuts		
			Kit BY MATIC 50 S - BMH 50 S a distanza  (ø 19x34) (4 vie) AR 903-1053-1203 - BHS 90-105-120 BHS-BHA-BHP 120 - 150 - 170 - 200 61,00 (997) With self-locking nuts		
BMS 50  (2 vie) for BHS 90-105-120-130-150-170-200	202,00 (965) 	8,00 (895) BHA-BHP 130-150-170-200 BHS 90-105-120-130-150-170-200			
			Kit BY MATIC 50 S - BMH 50 S a distanza		
			 (ø 19x34) (4 vie) AR 903-1053-1203 - BHS 90-105-120 BHS-BHA-BHP 120 - 150 - 170 - 200 61,00 (997) With self-locking nuts		
MANOMETRI / PRESSURE GAUGES (OPTIONAL) 		bar	Ø	Code	Price
		0 ÷ 25	100 mm	(1436)	62,00
		0 ÷ 15/60	63 mm	(1437)	54,00
		0 ÷ 8 / 25	63 mm	(1439)	54,00
		0 ÷ 6	63 mm	(1440)	14,00



ANNONI[®]
REVERBERI
HIGH PERFORMANCE PUMPS & WASHERS



Hydraulically driven high pressure pumps complete with unloader valve, pressure gauge, mt. 16 high pressure hose, lance and gun for boom sprayers, tractor mounted, trailed and self-propelled atomizers washing



HYD-XJS 11.14



Model	/ HP piston pump					/ Hydraulic motor						Cod.	Price	
	N° Piston	Delivery		Pressure		R.P.M.	Mot. "Sauer Danfoss" Tipo/Type	Motore	Volume cm ³	Pressure bar	Delivery L/min			Power HP
		L/min	gpm	bar	psi									
HYD - XJS 11.14	3	11	2.90	140	2030	2800	CI06 LFU1F 1 SNM2/8	4768	8,3	123	24,5	4	21659	743,00

HYD-XM 15.15



Model	/ HP piston pump					/ Hydraulic motor						Cod.	/ Price	
	N° Piston	Delivery		Pressure		R.P.M.	Mot. "Sauer Danfoss" Tipo/Type	Cod. Motore	Cilindrata Volume cm ³	Pressione Pressure bar	Portata Delivery L/min			Potenza Power HP
		L/min	gpm	bar	psi									
HYD - XM 15.15	3	15	3.96	150	2200	1450	CI06 LFU1F 1 SNM2/19	4769	19,2	105	29	5,5	21660	875,00

HYD-RK 15.20









Model	/ HP piston pump					/ Hydraulic motor						Cod.	/ Price	
	N° Piston	Delivery		Pressure		R.P.M.	Mot. "Sauer Danfoss" Tipo/Type	Motore	Volume cm ³	Pressure bar	Delivery L/min			Power HP
		L/min	gpm	bar	psi									
HYD - RK 15.20	3	15	3.96	200	2900	1450	CI06 LFU1F 1 SNM2/19	4769	19,2	175	29	7,5	21661	960,00

HYD-XW 30.10



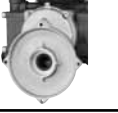







Model	/ HP piston pump					/ Hydraulic motor						Cod.	/ Price	
	N° Piston	Delivery		Pressure		R.P.M.	Danfoss" Tipo/Type	Motore	Volume cm ³	Pressure bar	Delivery L/min			Power HP
		L/min	gpm	bar	psi									
HYD - XW 30.10	3	30	7.92	100	1450	1450	CI06 LFU1F 1 SNM2/22	4770	22,8	125	36	7.5	21662	1.188,00

Gear units for electric motors, 2 and 4-stroke engines and for agricultural machinery



Pump type	Reduction ratio	Agricultural Machinery	Electric motor	Petrol engine	Price (code)	
AR DUE	 1:4,6 Motore 2 tempi	Con base motore		CM 46/CE • Ducati Salice • Famosa H 30 Oleomac S 50 • V.B. Master 50	58,00 (1606) [Ⓢ]	
	 Flangia	-	Monofase/Trifase HP 1,2 (Speciale AR)	-	34,00 (1603)	
AR 202 AR 252	 1:7,8 Motore 2 tempi (Alb. cilindrico)	Con base motore		CM 46/CE • Ducati Salice • Famosa H 60 Oleomac S 50 • V.B. Master 50	55,00 (1610) [Ⓢ]	
	 1:4,3 (Alb. cilindrico)	-	Monofase/Trifase (Speciale AR)	-	50,00 (1608)	
		1:6 (Alb. cilindrico Ø15,8-5/8") HP2,2/3	-	-	Honda G100 Kawasaki KF24	108,00 (1617)
		1:4,3 (Alb. cilindrico Ø19,05-3/4") HP3÷4	-	-	Briggs&Stratton IP093432 • Honda GX 120 K1 QX4 • GX 100 • Kawasaki KF34 DEXT2 • Kawasaki FA 130 N404 • Suzuki S150 Q • Suzuki V120 Q • Yamaha MF 180 • Subaru EH13 • Honda GC 135 • GC 160 Axo AMG 120 F1	94,00 (1613)
		1:4,3 (Alb. cilindrico Ø15,8 - 5/8"mm) HP3	-	-	Subaru EH 09	126,00 (1615) *
		1:4,3 (Alb. cilindrico Ø18mm) HP4,5	-	-	Honda GX 120 • Honda G 150 Subaru EX 13 (4,3 HP)	103,00 (1618) *
		1:6 (Alb. cilindrico Ø15) HP3	-	-	Subaru EH 09 Kama KB 30 HP 3 Axo AMG 100 F9	109,00 (1622)
	 1:7,8 (Alb. cilindrico Ø15mm) HP2,5	-	-	Honda GX H 50	121,00 (1605)	
AR 30 AR 303 AR 403	 1:8,8 Motore 2 tempi	-	-	CM 90/CE • CM 115/CE • V.B. Ercolino S 84 • Famosa H100 • F158 • F190	125,00 (1630)	
AR 30 AR 303 AR 403 AR 50 AR 503	 1:5,9 (Albero conico) Ø23mm HP4-7	-	-	Acme A180B • A220B • ALN 200WB ALN 330WB • Lombardini 15 LD 350	179,00 (1632)	

* Special reduction gears for special motors



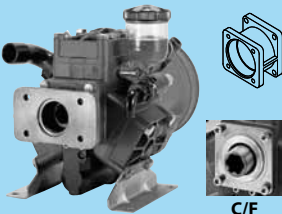

Pump type	Reduction ratio	Agricultural Machinery	Electric motor	Petrol engine	Price (code)
AR 30 AR 303 AR 403	 1:5,9 (Albero cilindrico Ø19,05-3/4" Flangia S.A.E. J609a) HP4-5,5	-	-	Axo AMG 160 F1 - Axo AMG 200 F1 Acme A180B Ext.2 - B&S IC 196432 • Honda G200 • Honda GC 135 • Honda GC 160 • Honda GX 160 • Honda G 200 • Honda GX 120 • Kawasaki FG 200 / FA 210 D / FA 170 D Honda GC 160 • Subaru EX 17 Subaru EX 21 • Kama KB 40 - KB 55 - KB 65 Kohler C56 T	165,00 (1636)
AR 50 AR 503	 1:5,9 (Albero cilindrico Ø25,4-1" Flangia S.A.E. J609a) HP7-18	-	-	Acme AL N290 WB Ext.2 • Acme AL N330WB Ext.2 Acme ADN 37 WB Ext.2 Kohler CS 8,5-CS10 - Kama KB 90-KB 130 Lombardini 15LD 350 • B&S 185432 Honda GX 240 • Kawasaki FE 290 / FE 250 D	181,00 (1639)
AR 713 AR 813				Acme VT 94 • Acme ADN 54 WB Ext.2 Kohler CS 12 • B&S 245432 B&S 245437 • Lombardini 15LD 500 Honda GX 340 • Kawasaki FE 350 • Kama Subaru EX 27	
AR 1064				Acme ADN 60 W Ext.2 • Acme AL 550 WB Ext.2 Ruggerini MD 150 • B&S 350447 • Honda G390 QX Honda GX 620 - Subaru EH41 - EH65 (HP 22)	
AR 30 AR 50 AR 303 AR 403 AR 503 AR 713 AR 813	 1:2,85	-	Monofase Trifase (Speciale AR)	-	116,00 (1624)
AR 30 AR 50	 1:2,6 Con disinnesto	vedi pag. 36÷57	-	-	227,00 (1646)
AR 303 AR 403 AR 503		1:4,5 Con disinnesto	vedi pag. 36÷57	-	-
AR 45 bp	 1:5,9 (Albero cilindrico Ø 19,05 - 3/4")	-	-	Axo AMG 160 F1 • Axo AMG 200 F1 • Acme A180B Ext.2 • B&S IC 196432 • Honda G200 • Honda GC 135 • Honda GC 160 • Honda GX 160 • Honda G 200 • Honda GX 120 • Kawasaki FG 200 / FA 210 D / FA 170 D • Honda GC 160 • Subaru EX 17 • Subaru EX 21 • Kama KB 40 - KB 55 - KB 65 • Kohler C56 T	181,00 (31086)
AR 70 bp AR 115 bp AR 135 bp	 1:5,9 (Albero cilindrico Ø 19,05 - 3/4")	-	-	B&S Intek Pro 124432 - 0141 E9 Honda EX 160	210,00 (1671)
AR 135 bp	 1:5,9 (Albero cilindrico Ø 1")	-	-	B&S 185432 - B&S 245432 Honda GX 240 - Honda GX 620	244,00 (1665)
AR 125 bp AR 145 bp	 1:5,9 (Albero cilindrico Ø 19,05 - 3/4")	-	-	B&S Intek Pro 124432 - 0141 E9 Honda EX 160	193,00 (1672)

Pump application price list for overgears on mounted and trained air-blast sprayers "FD"

Make	Type 	Code ²²	Pump type, version and fitting price			 C/F				
			AR 125 AR 145 AR 813 AR 1064	bp-C/F bp-C/F AP-C/F	AR 903 AR 1053 AR 1203 BHS 90 BHS 105 BHS 120		AP-C/F AP-C/F AP-C/F AP-C/F AP-C/F	BHA - BHP - BHS 130 AP-C/F BHA - BHP - BHS 150 AP-C/F BHA - BHP - BHS 170 AP-C/F BHA - BHP - BHS 200 AP-C/F		
BIMA	M 30 CS	5347	60,00							
	CAR 3 P (Foratura interna 70x82)	5344								
	CAR 3 P (Foratura esterna 160x75)	5345								
	M 30 N - M 47 N - M 60 N	5336								
CMV	MA 50 (Foratura interna 70x82)	5344	60,00							
	MA 50 (Foratura esterna 160x75)	5345								
	MA 86 - MA 86 S MA 107 - MA 107 S MA 110 - MA 110 S MA 110 3 V	5336								
	D 4 - D 7 - D 21 - D 27	5336					60,00			
	A 4 A	55364								
FIENI	Moltiplicatore V1	5346	60,00							
	CM - 9 PG	55354								
GB	AT 46 - AT 53 - AT 55 AT 65 - AT 70	5336	60,00							
	AT 39	5345								
	AP 102	55364								
	Moltiplicatore	55359					60,00			
R810 - R830 - R840	5336									

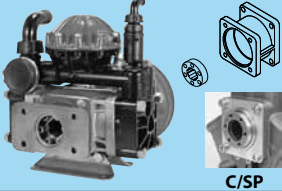
Pump application price list for overgears on mounted and trained air-blast sprayers "FDG"

Make	Type 	Code ²¹	Pump type, version and fitting price			 C/SP				
			AR 50 AP-C/SP AR 713 AP-C/SP AR 903 AP-C/SP BHS 90 AP-C/SP	AR 403 AP-C/SP AR 813 AP-C/SP AR 1053 AP-C/SP BHS 105 AP-C/SP	AR 503 AP-C/SP AR 1064 AP-C/SP AR 1203 AP-C/SP BHS 120 AP-C/SP					
BIMA	M 30 CS	5285	81,00							
	CAR 3 P (Foratura interna 70x82)	5328								
	CAR 3 P (Foratura esterna 160x75)	5330								
	M 30 N - M 47 N - M 60 N	5348								
CMV	MA 50 (Foratura interna 70x82)	5328	81,00							
	MA 50 (Foratura esterna 160x75)	5330								
	MA 86 - MA 86 S MA 107 - MA 107 S MA 110 - MA 110 S MA 110 3 V	5348								
	D 4 - D 7 - D 21 - D 27	5348					81,00			
	A 4 A	55365								
FIENI	Moltiplicatore V1	5290	81,00							
	CM - 9 PG	55355								
GB	AT 46 - AT 53 - AT 55 AT 65 - AT 70	5348	81,00							
	AT 39	5330								
	AP 102	55365								
REDUCO	R810 - R830 - R840	5348	81,00							

18

Price-list of fittings for hydraulic motors "IDM"



Make	Type	Code	Pump type, version and fitting price					
			AR 45 bp SP	AR 70 bp SP AR 115 bp SP AR 135 bp SP	AR 125 bp C/C AR 145 bp C/C AR 160 bp C/C AR 185 bp C/C AR 215 bp C/C AR 250 bp C/C AR 280 bp C/C AR 320 bp C/C	AR 330 bp C/C AR 410 bp C/C AR 460 bp C/C	AR 202 SP AR 252 SP AR 252 AP/SP	AR 903 C/SP AR 1053 C/SP AR 1203 C/SP AR 305P AR 505P - AR 3035P AR 4035P - AR 5035P AR 713 C/SP AR 813 C/SP AR 1064 C/S BHS 90 C/SP BHS 105 C/SP BHS 120 C/SP
CASAPPA	Serie RBO - RBP - RBR Ø 25 mm	55353	-	-	-	75,00	-	
		5350	88,00	-	-	-	-	
	Serie RBS Z=14	5349	-	127,00	-	-	-	
WHITE HIDRAULICS	Serie RS Ø 25 mm	55353	-	-	-	75,00	-	
	Serie DR - MB - RS Ø 25 mm	5350	88,00	-	-	-	-	
	Serie DR - MB - RE Z=14	5349	-	127,00	-	-	-	
SAUER DANFOSS	OMP 25-32-40-50 albero Ø25mm 80 - 100 - 160 - OMR 80 - OMR 100	55372	88,00	-	-	-	-	
		55353	-	-	-	75,00	-	
		5350	88,00	-	-	-	-	
		5327	-	-	-	-	103,00	
	OMP 50 albero Ø25,4mm (Ø1") 80 - 100 - 160 - OMR 80 - OMR 100	1568	-	127,00	-	-	-	
		5341	88,00	-	-	-	-	
		5312	-	-	-	-	103,00	
	OMS albero Ø32mm	1570	-	127,00	-	-	-	
		1569	-	127,00	-	-	-	
OMS albero Z=14	55371	-	-	149,00	-	-		
5349	-	127,00	-	-	-	-		
CHAR-LYNN EATON	Serie 2000 albero Ø25,4mm (Ø1") Tipo 2 - 80,2 - 100,2 - 160	5312	-	-	-	-	103,00	

19









Price-list of fittings for hydraulic pumps "IDP"

Make	Type	Code	Pump type, version and fitting price		
			AR 125 bp C/C - AR 145 bp C/C AR 160 bp C/C - AR 185 bp C/C AR 215 bp C/C - AR 250 bp C/C AR 280 bp C/C - AR 320 bp C/C AR 370 bp C/C - AR 500 bp C/C AR 560 bp C/C	AR 330 bp C/C AR 410 bp C/C AR 460 bp C/C	AR 903 C/SP - AR 1053 C/SP - AR 1203 C/SP AR 30AP - AR 50AP AR 403AP - AR 503AP - AR 713 C/SP AR 813 C/SP - AR 1064 C/SP BHS 90 C/SP - BHS 105 C/SP - BHS 120 C/SP
CASAPPA - SALAMI DOWTY - TUROLLA PLESSEY LAMBORGHINI	Pompe gruppo 2 con albero conico 1:8 + giunto scanalato B35x31 - DIN 5482 e flangia rettangolare	55352	122,00	-	-
CASAPPA SALAMI	Pompe gruppo 3 Flangia SAE - 1"	5335	-	-	103,00
AMA (art. 17249)	Moltiplicatore su pompa idraulica gruppo 2	55351	122,00	-	-
AMA	Moltiplicatore 1"3/8 F su pompa gruppo 3	55358	122,00	-	-
BIMA	Moltiplicatore 1"3/8 F su pompa gruppo 3				
HYDR_APP	Moltiplicatore ML 52-2 su pompa gruppo 3	55370	-	122,00	-
	Moltiplicatore ML 52-2 su pompa gruppo 3				
	Moltiplicatore ML 32-2	55351	122,00	-	-

OPTIONAL

Spare parts supplied on request (Code . . .)

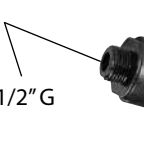
Universal shaft guard

	Pump type	Version	Outlet side	Flange and standard shaft side	Price
 (1493)	AR 115/1000, 70, 115, 135bp	C	1498	-	7,00
	AR 70, 115, 135bp	SP	-	1492/1498	7,00
 (1492)	AR 125, 145, 160, 185, 250, 280, 410, 460, 370, 500, 560bp	C/C	1492	1492/1498	7,00
				1493	10,00
 (1498)	AR 202, AR 252, AR 252 AP	SP	-	1490	8,00
	AR 30, AR 50, AR 303, AR 403, AR 503	SP	-	1492/1498	7,00
 (1490)	AR 30, AR 50, AR 403 AP	C/SP	1498	1492/1498	7,00
	AR 503 AP	C/SP	1497	1492/1498	7,00
 (1497)	AR 713, 813, 1064 AP	C/SP-C/C-C/F	1492	1492/1498	7,00
				1493	10,00
 (1499)	AR 903, 1053, 1203 AP	C/SP-C/C-C/F	1492	1492/1498	7,00
				1493	10,00
 (1497)	BHS 90, 105, 120 AP	C/SP-C/C-C/F	1492	1492/1498	7,00
				1493	10,00
 (1497)	BHA/BHP/BHS 130-150-170-200 AP	C/C-C/F	1492	1492/1498	7,00
				1493	10,00

Closed guard



A RICHIESTA

/ Pump type	Cod.	Price
AR 125 bp, AR 145 bp	1480	11,50
AR 713, AR 813, AR 1064	1481	
BHA/BHS/BHP 130, 150, 170, 200, AR 410, 460 bp	1482	
AR 160, 185, 215, 250, 280, 320, 370, 500, 560 bp	1484	

Safety valve



A RICHIESTA

Pressione / bar	Cod.	Price
20	1432	13,00
40	1433	
50	1434	

Safety valve kit





/ Only	/ bar	Cod.	Price
AR DUE - AR 202 - AR 252	20	1435	20,00
AR 303 - AR 403	40	1441	22,00



OPTIONAL



Spare parts supplied on request (Code . . .)



	COMBIJET 2 - Teejet (4 vie)	- Nozzle attachment	1392	16,00
	COMBIJET 2 - Albuz (4 vie)	- Nozzle attachment	1393	

	SIGNAL BOX for Pump Saver® Kit	2420	48,00
---	--------------------------------	------	--------------

PUMP SAVER® KIT / Pump saver			
	/ For	Cod.	/ Price
	AR 125 bp - AR 145 bp - AR 160 bp - AR 185 bp AR 215 bp - AR 250 bp - AR 280 bp AR 320 bp - AR 370 bp - AR 500 bp - AR 560 bp - TWIN AR 1064 BHA 130 - BHA 150 - BHA 170 - BHA 200 AR 903 - AR 1053 - AR 1203 BHS 90 - BHS 105 - BHS 120 - BHS 130 BHS 150 - BHS 170 - BHS 200	2400	53,50
	AR 713 AR 813	2401	44,50
	AR 115 bp AR 135 bp AR 303 AR 403 AR 503	2414	53,50

Remote tank kit			
	/ For	Cod.	/ Price
	AR 70 bp - AR 115 bp - AR 135 bp - AR 50 - AR 303 - AR 403 - AR 503 - AR 903 AR 1053 - AR 1203 - BHS 90 - BHS 105 - BHS 120	2471	32,00
	AR 713 - AR 813 - AR 1064 AR 125 bp - AR 145 bp - AR 160 bp AR 185 bp - AR 370 bp	2428	33,00
	BHA 130 - BHA 150 - BHA 170 - BHA 200 BHP 130 - BHP 150 - BHP 170 - BHP 200 BHS 130 - BHS 150 - BHS 170 - BHS 200	2468	36,00

Motor-driven pump and electric pump assemblies for gardening.

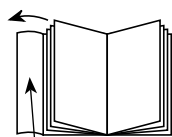

Pump type

see
for 10 12 17 23 25

Versions	Motor			Price (code)
	Motor make, type and code /	Type of fuel	MAX HP / KW	
AR DUE DC V.R.I. 	DC	12Volt (4510)	(Max10 bar) 12 25 /D.C. electric motor)	0,34/0,25 471,00 (95)
	DC	24Volt (4112)	(Max10 bar) 12 25 /D.C. electric motor)	0,34/0,25 487,00 (96)
 AR DUE V.R.I.	EM	Monofase (4444)	(Max25 bar) 12 25 17 V 220/240 4 poli monofase	1,2/0,9 370,00 (145)
	ET	Trifase (4647)	(Max25 bar) 12 25 V 230/400 4 poli trifase	1,2/0,9 404,00 (146)
 AR DUE V.R.I.	S	CM 46 /CE (4023)	Miscela 23 10	2/1,5 522,00 (131)
	S	Oleomac S 50 (4004)	Miscela 23 10	1,8/1,3 545,00 (129)
 AR 202 V.R.I.	EM	Monofase (4030)	12 25 17 V 220/240 2 poli monofase	1,2/0,9 418,00 (202)
	ET	Trifase (4034)	12 25 V 230/400 2 poli trifase	1,2/0,9 463,00 (203)
 AR 202 V.R.I.	S	CM 46/CE (4023)	Miscela 23 10	2/1,5 527,00 (205)
	S	Oleomac S 50 (4004)	Miscela 23 10	1,8/1,3 552,00 (206)
	S	NEW Axo AMG 100 F9 (44435)	Miscela 12 10 Benzina	2,5/1,8 570,00 (237)
 AR 252 GR 30	EM	Monofase (4030)	12 25 V 220/240 2 poli monofase	1,5/1,1 445,00 (215)
	ET	Trifase (4798)	12 25 V 230/400 2 poli trifase	1,5/1,1 485,00 (216)
 AR 252 GR 30	S	Kama KB 30D (44316)	(Max20 bar) 12 10 Benzina	2,5/1,8 595,00 (231)
	S	NEW Axo AMG 100 F9 (44435)	(Max20 bar) 12 10 Benzina	2,5/1,8 595,00 (234)
	S	NEW Axo AMG 120 F1 (44442)	12 10 Benzina	4/3 625,00 (31114)
	S	Briggs&Stratton IP 093432-1036-E1 (4005)	12 10 Benzina	3,5/2,7 931,00 (226)
	S	Honda GX 120 (4904)	12 10 Benzina	4/3 1.027,00 (228)
	S	Honda GC 135 (4605)	12 10 Benzina	4/3 840,00 (229)
	S	Honda GC 160 (4130)	12 10 Benzina	5/3,7 893,00 (221)

Motor-driven pump and electric pump assemblies for gardening.

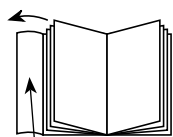

Pump type

see for 10 11 12 13 16 17

AR 303

GR 40

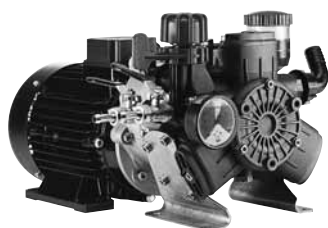

AR 303

GR 40

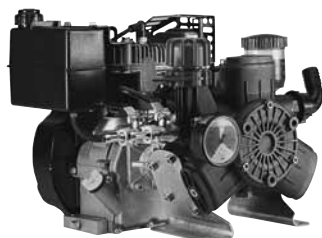

AR 403

GR 40



AR 403

GR 40

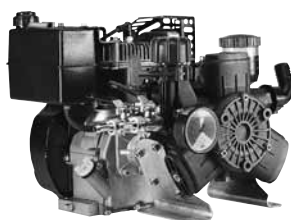

Versions	Motor			Price (code)
	Motor make, type and code /	Type of fuel	MAX HP / KW	
EM	Monofase (Max30 bar) (4057) 12 16	V 220/240 4 poli monofase	2/1,5	805,00 (241)
EM	Monofase (Max35 bar) (4058) 12 16 17	V 220/240 4 poli monofase	2,5/1,8	812,00 (242)
EM	Monofase (Max40 bar) (4077) 12 16	V 220/240 4 poli monofase	3/2,2	835,00 (243)
ET	Trifase (Max30 bar) (4059) 12 16	V 230/400 4 poli trifase	2,5/1,8	759,00 (244)
ET	Trifase (Max35 bar) (4076) 12 16	V 230/400 4 poli trifase	3/2,2	792,00 (245)
ET	Trifase (Max40 bar) (4078) 12 16	V 230/400 4 poli trifase	4/3	821,00 (246)
S	Kama KB 65 D2 (44317) 15 12 10	Benzina	6,5/4,7	840,00 (260)
S	NEW Axo AMG 200 F1 (44359) 15 13 10	Benzina	6,5/4,7	840,00 (261)
S	Kohler CS 6T (44312) 12 10	Benzina	5/3,7	1.228,00 (259)
S	Briggs&Stratton (4523) Intek Pro 123432-0141-E1 12 10	Benzina	6,5/4,7	1.168,00 (253)
S	Honda GC 135 (4605) 12 10	Benzina	4/3	1.056,00 (256)
S	Honda GC 160 (4130) 12 10	Benzina	5/3,7	1.109,00 (257)
S	Honda GX 160 (4903) 15 12 10	Benzina	5,5/4	1.261,00 (255)
EM	Monofase (Max30 bar) (4077) 12 16	V 220/240 4 poli monofase	3/2,2	843,00 (466)
ET	Trifase (Max30 bar) (4076) 12 16	V 230/400 4 poli trifase	3/2,2	803,00 (467)
ET	Trifase (Max35 bar) (4078) 12 16	V 230/400 4 poli trifase	4/3	824,00 (468)
ET	Trifase (Max40 bar) (4084) 12 16	V 230/400 4 poli trifase	5,5/4	912,00 (469)
S	Kama KB 65 D2 (44317) 15 12 10	Benzina	6,5/4,7	848,00 (481)
S	NEW Axo AMG 200 F1 (44359) 15 10 12	Benzina	6,5/4,7	848,00 (31084)
S	Kohler CS 6T (44312) 12 10	Benzina	5/3,7	1.233,00 (480)
S	Briggs&Stratton (4523) Intek Pro 123432-0141-E1 15 12 10	Benzina	6,5/4,7	1.174,00 (475)
S	Honda GC 160 (4130) 12 10	Benzina	5/3,7	1.116,00 (478)
S	Honda GX 160 (4903) 15 12 10	Benzina	5,5/4	1.268,00 (476)

Motor-driven pump and electric pump assemblies.

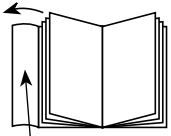

Pump type

see for 10 11 12 13 15 16 17

AR 30

GI 40

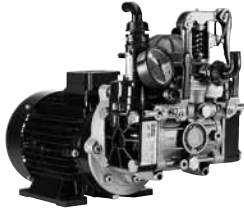

AR 30

GI 40

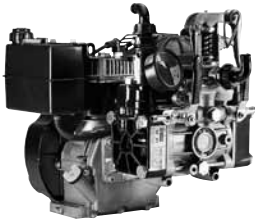

AR 50

GI 40

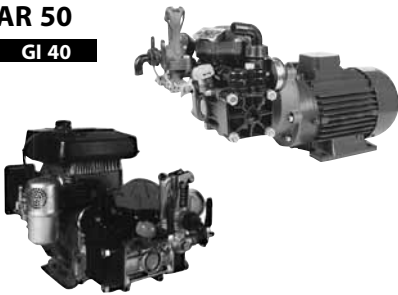

AR 503

RM 40 I







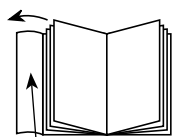

Versions	Motor			Price
	Motor make, type and code /	Type of fuel	Pot. MAX HP / KW	
EM	Monofase (Max30 bar) (4058) 12 16 17	V 220/240 4 poli monofase	2,5/1,8	826,00 (346)
EM	Monofase (Max35 bar) (4077) 12 16	V 220/240 4 poli monofase	3/2,2	846,00 (347)
ET	Trifase (Max30 bar) (4059) 12 16	V 230/400 4 poli trifase	2,5/1,8	772,00 (380)
ET	Trifase (Max35 bar) (4076) 12 16	V 230/400 4 poli trifase	3/2,2	810,00 (348)
ET	Trifase (Max40 bar) (4078) 12 16	V 230/400 4 poli trifase	4/3	831,00 (349)
S NEW	Axo AMG 200F1 (44359) 15 10 11	Benzina	6,3/4,7	854,00 (341)
S	Kama KB 65 D2 (44317) 15 12 10	Benzina	6,5/4,7	854,00 (339)
S	Kohler CS 6T (44312) 15 12 10	Benzina	5/5,4	1.230,00 (354)
S	Briggs&Stratton Intek Pro 123432-0141-E1 (4523) 15 12 10	Benzina	6,5/4,7	1.170,00 (333)
S	Honda GC 135 (4605) 12 10	Benzina	4/3	1.068,00 (350)
S	Honda GC 160 (4130) 12 10	Benzina	5/3,7	1.122,00 (351)
S	Honda GX 160 (4903) 15 12 10	Benzina	5,5/4	1.273,00 (329)
ET	Trifase (Max 35 bar) (4084) 12 16	V 230 / 400 4 poli trifase	5,5/4	1.022,00 (435)
ET	Trifase (Max 40 bar) (4085) 12 16	V 230 / 400 4 poli trifase	7,5/5,5	1.058,00 (441)
S	Briggs&Stratton 185432- 0553- E1 (4921) 12 10 15	Benzina	9/6,8	1.712,00 (430)
S	Honda GX 270 (4925) 12 10 15	Benzina	9/6,8	1.854,00 (420)
SD	Lombardini 15LD 350 (4786) 12 10 15	Gasolio	7,5/5,5	3.049,00 (434)
ET	Trifase (Max35 bar) (4084) 12 16	V 230 / 400 4 poli trifase	5,5/4	997,00 (520)
ET	Trifase (4085) 12 16	V 230 / 400 4 poli trifase	7,5/5,5	1.033,00 (519)
S	Brigg&Stratton 185432-0553-E1 Serie Vanguard (4921) 12 10 15	Benzina	8/5,8	1.692,00 (525)
S	Honda GX 270 (4925) 12 10 15	Benzina	9/6,8	1.830,00 (521)
SD	Lombardini 15LD 350 (4786) 12 10 15	Gasolio	7,5/5,5	3.024,00 (528)

Motor-driven pump and electric pump assemblies.

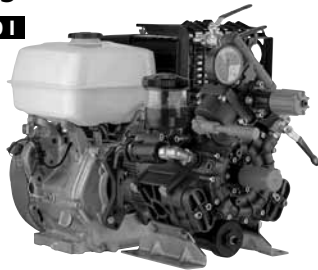
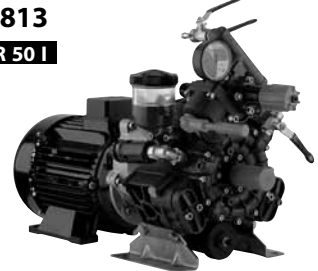











Pump type

see for 10 12 14 15 16 27

Versions	Motor			Price (code)
	Motor make, type and code /	Type of fuel	. MAX HP / KW	
AR 713 VDR 50 I 	ET	Trifase (4085) 12 16	V 380 / 400 4 poli trifase	7,5/5,5 1.244,00 (655)
	S	Honda GX 340 (4926) 12 10 15	Benzina	11/8,2 2.415,00 (657)
	S	Briggs&Stratton 245432-0235-E1 Serie Vanguard (4922) 12 10 15	Benzina	13/9,6 2.452,00 (658)
	SD	Lombardini 15LD 500 - (Ø1") (44004) 12 10 15	Gasolio	12/8,8 4.459,00 (662)
AR 813 VDR 50 I 	ET	Trifase (Max40 bar) (4086) 12 16	V 380 / 400 4 poli trifase	8,5/6,2 1.309,00 (670)
	S	Honda GX 390 (Max40 bar) (4554) 12 10 15	Benzina	13/9,6 2.493,00 (671)
	S	Briggs&Stratton 245432 - 0235 - E1 Serie Vanguard (Max40 bar) (4922) 12 10 15	Benzina	13/9,6 2.518,00 (676)
	SD	Lombardini 15LD 500 - (Ø1") (Max40 bar) (44004) 12 10 15	Gasolio	12,2/9 4.476,00 (663)
AR 1064 VDR 50 I 	S	Briggs&Stratton 350447 - 1185 - E1 Serie Vanguard (4924) 12 14	Benzina	18/13,4 4.646,00 (772)
	S	Honda GX 620 (4019) 12 27 14	Benzina	20/14,7 5.009,00 (771)
AR 70 bp S.G.C. 	S	Honda GX 120 (Max15 bar) (4904) 12 10	Benzina	4/3 1.355,00 (1190)
	S	Briggs&Stratton Intek Pro 123432-0141-E9 (Max20 bar) (4523) 15 12 10	Benzina	6,5/4,7 1.303,00 (1191)
AR 115 bp S.G.C. 	S	Honda GX 160 (Max10 bar) (4903) 15 12 10	Benzina	5,5/4 1.504,00 (1192)
	S	Briggs&Stratton Intek Pro 123432-0141-E1 (Max10 bar) (4523) 15 12 10	Benzina	6,5/4,7 1.431,00 (1193)
AR 135 bp S.G.C. 	S	Honda GX 270 (Max15 bar) (4925) 15 12 10	Benzina	9/6,8 2.074,00 (1189)
	S	Briggs&Stratton Intek Pro 123432-0141-E1 (Max10 bar) (4523) 15 12 10	Benzina	6,5/4,7 1.444,00 (1195)
AR 125 bp S.G.C. 	S	Honda GX 160 (Max10 bar) (4903) 15 12 10	Benzina	5,5/4 1.692,00 (1187)
	S	Briggs&Stratton Intek Pro 123432-0141-E1 (Max10 bar) (4523) 15 12 10	Benzina	6,5/4,7 1.596,00 (1188)
AR 145 bp S.G.C. 	S	Honda GX 160 (Max10 bar) (4903) 15 12 10	Benzina	5,5/4 1.713,00 (1196)
	S	Briggs&Stratton Intek Pro 123432-0141-E1 (Max10 bar) (4523) 15 12 10	Benzina	6,5/4,7 1.617,00 (1197)



27 - Engine without fuel tank

Bases, frames, trolleys, wheel barrows and hose reels for motor-driven pump and electric pump assemblies for gardening (Code...)





Type		AR DUE AR 202 AR 252	AR 30 AR 303 AR 403
	2-wheeled trolley For S-EM-ET	92,00 (3900)	92,00 (3900)
	C 2-Wheeled trolley with hose-reel, without: outlet, suction and return hoses, filter and lance	130,00 (3944)	-
	CAR/A - 2 -wheeled trolley with hose reel+100m hose and 60cm lance	283,00 (3968)	-
	CAR/A - 2 -wheeled trolley with hose reel+100m hose and 60cm lance	322,00 (3941)	-
	CAR 35 Dolly with two wheels and built-in 35 l polyethylene tank, 5 m rubber hose and 60 cm nozzle.	207,00 (3969)	-
	CAR 50 2-wheeled trolley c/w 50 lt. polypropylene tank 5 m hose and 60 cm. lance	303,00 (3935)	-
	CAR 75 Wheelbarrow c/w polyethylene 75L tank, 10m hose, 60cm lance and 5L hand washer tank.	411,00 (3929)	-
	CAR 90/H 2 -wheeled trolley c/w polyethylene tank 90L, 10m hose, 60cm lance and 5L hand washer tank.	432,00 (3930)	-
	CAR 90/P 2 -wheeled trolley c/w polyethylene tank 90L, 10m hose, 60cm lance and hand washer tank.	-	442,00 (3931)
	CAR 130/H 2 -wheeled trolley c/w polyethylene tank 130L, 10m hose, 60cm lance and hand washer tank.	474,00 (3932)	-
	CAR 130/P 2 -wheeled trolley c/w polyethylene tank 130L, 10m hose, 60cm lance and 5L hand washer tank.	-	484,00 (3933)



Hose reels for trolleys and wheel barrows for gardening(Code...)

Type		AR DUE	
		AR 202 / AR 252	AR 303 / AR 403
	Hose-reel 50 mt with brackets for CAR50 without hose	120,00 (3911)	-
	Hose-reel PL 50 mt with brackets for CAR75 and CAR90 without hose	182,00 (3917)	182,00 (3917)
	/ Hose-reel PL 50 mt with brackets for CAR130 without hose	182,00 (3918)	182,00 (3918)
	/ Hose-reel 100 mt with brackets for CAR75 and CAR90 without hose	125,00 (3919)	125,00 (3919)
	/ Hose-reel 100 mt with brackets for CAR130 without hose	125,00 (3920)	125,00 (3920)
	/ Hose-reel and 50 mt hose for CAR50	156,00 (3910)	-
	/ Hose-reel and 50 mt rubber 8x13 diameter hose for CAR50	167,00 (3960)	-
	/ PL Hose-reel and 50 mt rubber 8x13 diameter hose for CAR75 and CAR90	229,00 (3921)	-
	Avvolgitubo PL gomma telata 8x13/50 mt per CAR130 / PL Hose-reel and 50 mt rubber 8x13 diameter hose for CAR130 / Enrouler PL et tuyau en caoutchouc 8x13 50 mt pour CAR130 / Enrollador PL y manguera 8x13 50 mt para CAR130 / PL-Schlauchtrommel, 50 mt und 8x13 Schlauch aus Gummi für CAR130	229,00 (3922)	-
	/ PL Hose-reel and 50 mt rubber 10x17 diameter hose for CAR75 and CAR90	-	255,00 (3923)
	/ PL Hose-reel and 50 mt rubber 8x13 diameter hose for CAR130	-	255,00 (3924)
	/ Hose-reel and 100 mt rubber 8x13 diameter hose for CAR75 and CAR90	219,00 (3925)	-
	/ Hose-reel and 100 mt rubber 8x13 diameter hose for CAR130	219,00 (3926)	-
	/ Hose-reel and 100 mt rubber 10x17 diameter hose for CAR75 and CAR90	-	255,00 (3927)
	/ Hose-reel and 100 mt rubber 10x17 diameter hose for CAR130	-	255,00 (3928)
	/ Rubber hose L = 50 m	49,00 (651200)	77,00 (651340)
	/ Rubber hose L = 100 m	78,00 (651180)	140,00 (651150)

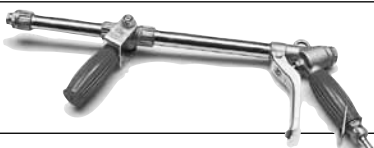
Various accessories for gardening(Code...)

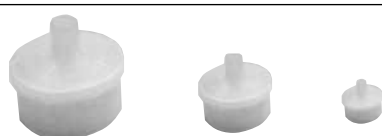
	Lance with handle	Ø 8	26,00 (3830)
		Ø 10	26,50 (3831)
	Lance with lever	Ø 8	33,00 (3832)
		Ø 10	33,00 (3833)
	Special lance	Ø 10	96,00 (3829)
	Turbo lance	Ø 10	69,00 (3998)
	Suction filter	Ø 20	4,20 (800870)
		Ø 25	4,20 (3816)
		Ø 30	4,20 (3817)
		Ø 40	4,20 (3823)

Price-list pump with control unit and fitting for agricultural machines (5...) = Code for flange only

MARCA	Tipo	APPLICAZIONE	AR 202 (VRI)	AR 252 (GR 30)	AR 30 (GI 40)	AR 303 (GR 40)	AR 403 (GR 40)	AR 50 (GI 40)	AR 503 (RM 40)
ADRIATICA	Master Mec HP 10 - Maior Mec	FM	-	-	440,30 (5121)	426,30 (5121)	433,30 (5121)	549,30 (5121)	517,30 (5121)
	Super Mec	FM	-	-	440,30 (5124)	426,30 (5124)	433,30 (5124)	549,30 (5124)	517,30 (5124)
	Omega Furetto	Rid. 1:4,5 cod.1645 con disinnesto	-	-	641,30 (5298)	627,30 (5298)	634,30 (5298)	750,30 (5298)	718,30 (5298)
AGRIA	1900D - 2800D - 2900 - 3800	◆ FM	-	-	475,30 (5132)	461,30 (5132)	468,30 (5132)	584,30 (5132)	552,30 (5132)
	2500 (Presa di forza inferiore)	FM	-	-	440,30 (5134)	426,30 (5134)	433,30 (5134)	549,30 (5134)	517,30 (5134)
	2500 - 8000 - 9000 (Presa di forza superiore)	Rid. 1:4,5 cod.1645 con disinnesto	-	-	641,30 (5135)	627,30 (5135)	634,30 (5135)	750,30 (5135)	718,30 (5135)
	7000	Rid. 1:4,5 cod.1645 con disinnesto	-	-	641,30 (5332)	627,30 (5332)	634,30 (5332)	750,30 (5332)	718,30 (5332)
ANTONELLI	Agrella 45 - 16 Guidella 26 - 32 - 45 Rangers	Giunto e piedi	-	-	395,80 (5182)	381,80 (5182)	388,80 (5182)	-	472,80 (5182)
ASSEMBLY	Multiply 14/D - 14/DR	Rid. 1:4,5 cod.1645 con disinnesto	-	-	641,30 (5135)	627,30 (5135)	634,30 (5135)	750,30 (5135)	718,30 (5135)
	Multiply 10/2T - 4T - 10D	Rid. 1:4,5 cod.1645 con disinnesto	-	-	641,30 (5240)	627,30 (5240)	634,30 (5240)	750,30 (5240)	718,30 (5240)
	Daily 8	○ FM	304,50 (5002)	343,80 (5002)	452,80 (5144)	438,80 (5144)	445,80 (5144)	561,80 (5144)	529,80 (5144)
	Sevent 7	FM	-	-	440,30 (5200)	426,30 (5200)	433,30 (5200)	-	-
BARBIERI	Gazzella	Rid. 1:4,5 cod.1645 con disinnesto	-	-	641,30 (5280)	627,30 (5280)	634,30 (5280)	750,30 (5280)	718,30 (5280)
	Leopard -Panter - Delfino - Terra Trac	○ FM	-	-	452,80 (5139)	438,80 (5139)	445,80 (5139)	561,80 (5139)	529,80 (5139)

Segue

Price-list pump with control unit and fitting for agricultural machines (5...) = Code for flange only



MARCA	Tipo	APPLICAZIONE	AR 202 (VRI)	AR 252 (GR 30)	AR 30 (GI 40)	AR 303 (GR 40)	AR 403 (GR 40)	AR 50 (GI 40)	AR 503 (RM 40)
BARBIERI	Pioneer - Tiger - Giaguaro - Ghepard ○	FM	304,50 (5001)	343,80 (5001)	452,80 (5141)	438,80 (5141)	445,80 (5141)	561,80 (5141)	529,80 (5141)
	Falcon - Condor	Rid. 1:4,5 cod.1645 con disinnesto	-	-	641,30 (5140)	627,30 (5140)	634,30 (5140)	750,30 (5140)	718,30 (5140)
	Laser - Bravo	FM	-	-	440,30 (5313)	426,30 (5313)	433,30 (5313)	-	-
	Zebra	FM	-	-	440,30 (5174)	426,30 (5174)	433,30 (5174)	-	-
BCS	601 - 602 - 603 - 612 - 715 - 725 735 - 737 ○	FM	304,50 (5002)	343,80 (5002)	452,80 (5144)	438,80 (5144)	445,80 (5144)	561,80 (5144)	529,80 (5144)
	705 - 755 1000 G/1'	Rid. 1:2,6 cod.1646 con disinnesto	-	-	667,30 (5143)	653,30 (5143)	660,30 (5143)	776,30 (5143)	744,30 (5143)
	600 - 610 - 620 - 630 - 640 - 650 710 - 720 - 730 - 740 ○	FM	-	-	452,80 (5342)	438,80 (5342)	445,80 (5342)	561,80 (5342)	529,80 (5342)
	745 ◆	FM	-	-	475,30 (5322)	461,30 (5322)	468,30 (5322)	584,30 (5322)	552,30 (5322)
	SYCAR 20 RS	FM	-	-	440,30 (5124)	426,30 (5124)	433,30 (5124)	549,30 (5124)	517,30 (5124)
BEDOGNI	Colibri - Scampolo	FM	292,00 (5003)	331,30 (5003)	-	-	-	-	-
	Mini Olimpia ○	FM	304,50 (5001)	343,80 (5001)	452,80 (5141)	438,80 (5141)	445,80 (5141)	561,80 (5141)	529,80 (5141)
	RB 14 ○	FM	-	-	452,80 (5139)	438,80 (5139)	445,80 (5139)	561,80 (5139)	529,80 (5139)
BENASSI	BL 100	Rid. 1:4,5 cod.1645 con disinnesto	-	-	641,30 (5298)	627,30 (5298)	634,30 (5298)	750,30 (5298)	718,30 (5298)
	BL 120 - BL 105	Rid. 1:4,5 cod.1645 con disinnesto	-	-	641,30 (5269)	627,30 (5269)	634,30 (5269)	750,30 (5269)	718,30 (5269)

Segue

Price-list pump with control unit and fitting for agricultural machines (5...) = Code for flange only

MARCA	Tipo	APPLICAZIONE	AR 202 (VRI)	AR 252 (GR 30)	AR 30 (GI 40)	AR 303 (GR 40)	AR 403 (GR 40)	AR 50 (GI 40)	AR 503 (RM 40)
BENASSI	RL 15 R	Rid. 1:4,5 cod.1645 con disinnesto	-	-	641,30 (5146)	627,30 (5146)	634,30 (5146)	750,30 (5146)	718,30 (5146)
	BL40-RL40-RL50-RL75-Z600-BL75-BL85-RL9-BL55 Z500-Z520-RT10-RT12-BM80-R90-R250-Z450-Z750	FM	-	-	440,30 (5268)	426,30 (5268)	433,30 (5268)	-	-
	300 - 350 - 450 - 407 - 408 (Attacco rapido)	FM	-	-	440,30 (5315)	426,30 (5315)	433,30 (5315)	549,30 (5315)	517,30 (5315)
	RT 80	FM	-	-	440,30 (5301)	426,30 (5301)	433,30 (5301)	549,30 (5301)	517,30 (5301)
	331-332-444-334-631-632-633-308-325-327 328-634-RL301-302-303-304-serie 300	Rid. 1:4,5 cod.1645 con disinnesto	-	-	641,30 (5147)	627,30 (5147)	634,30 (5147)	750,30 (5147)	718,30 (5147)
BERTOLINI	BM 10 - 310 - 324 - 330 - 510 ○	FM	-	-	452,80 (5148)	438,80 (5148)	445,80 (5148)	561,80 (5148)	529,80 (5148)
	BM 12	FM	-	-	440,30 (5149)	426,30 (5149)	433,30 (5149)	549,30 (5149)	517,30 (5149)
	Transporter BTR 350V	Rid. 1:4,5 cod.1645 con disinnesto	-	-	641,30 (55362)	627,30 (55362)	634,30 (55362)	-	-
	Serie 320	FM	-	-	440,30 (5150)	426,30 (5150)	433,30 (5150)	549,30 (5150)	517,30 (5150)
	Serie 300 - 302 - 305 - 307 - 315 - 318	FM	-	-	440,30 (5151)	426,30 (5151)	433,30 (5151)	549,30 (5151)	517,30 (5151)
	300 - 302 - 305 - 307 - 315 - 318 Motofalce 131 - 306 - 308 - 312 quick fit 134 - 136 - 405 - 406 - 408 - 140 - 141 - 141M 410 - 411 - FC 20/30/30M - Kam 4/5 ◆	FM	-	-	475,30 (5266)	461,30 (5266)	468,30 (5266)	584,30 (5266)	552,30 (5266)
	Motofalce 131-134-136-306-308-312-405 ○ 406-408 (Flangiatura senza att. rapido) 140 141 - 141 M - 410 - 411 - FC 20/30/30M - Kam 4/5	FM	304,50 (5022)	343,80 (5022)	452,80 (5331)	438,80 (5331)	445,80 (5331)	561,80 (5331)	529,80 (5331)
	Motoagricola TA 2025 ◆	FM	-	-	475,30 (55368)	461,30 (55368)	468,30 (55368)	584,30 (55368)	552,30 (55368)
314 - 600 - 700 - 800 MAK 6/7/8	FM	-	-	440,30 (5221)	426,30 (5221)	433,30 (5221)	549,30 (5221)	517,30 (5221)	

Price-list pump with control unit and fitting for agricultural machines (5...) = Code for flange only



MARCA	Tipo	APPLICAZIONE	AR 202 (VRI)	AR 252 (GR 30)	AR 30 (GI 40)	AR 303 (GR 40)	AR 403 (GR 40)	AR 50 (GI 40)	AR 503 (RM 40)
BIAGIOLI	Revert 1300 - 2104 - 3004 ○	FT	-	-	452,80 (5256)	438,80 (5256)	445,80 (5256)	561,80 (5256)	529,80 (5256)
BONORI	Serie 800 - Sapper	FM	-	-	440,30 (5156)	426,30 (5156)	433,30 (5156)	549,30 (5156)	517,30 (5156)
	Serie 900 ◆	Rid. 1:4,5 cod.1645 con disinnesto	-	-	676,30 (5158)	662,30 (5158)	669,30 (5158)	785,30 (5158)	753,30 (5158)
	Serie 400	Rid. 1:4,5 cod.1645 con disinnesto	-	-	641,30 (5159)	627,30 (5159)	634,30 (5159)	750,30 (5159)	718,30 (5159)
BREDA	Prater-Maxima ○	FM	304,50 (5001)	343,80 (5001)	452,80 (5141)	438,80 (5141)	445,80 (5141)	561,80 (5141)	529,80 (5141)
	Teolo ○	FT	-	-	452,80 (5139)	438,80 (5139)	445,80 (5139)	561,80 (5139)	529,80 (5139)
	Leopard - Panter - Torello - Mastino	Rid. 1:4,5 cod.1645 con disinnesto	-	-	641,30 (5160)	627,30 (5160)	634,30 (5160)	750,30 (5160)	718,30 (5160)
BRUMI	327 ○	FM	304,50 (5002)	343,80 (5002)	452,80 (5144)	438,80 (5144)	445,80 (5144)	561,80 (5144)	529,80 (5144)
	331	FM	-	-	440,30 (5143)	426,30 (5143)	433,30 (5143)	549,30 (5143)	517,30 (5143)
	Mini Rekord - Rekord - Simplex Muletto	Rid. 1:4,5 cod.1645 con disinnesto	-	-	641,30 (5161)	627,30 (5161)	634,30 (5161)	750,30 (5161)	718,30 (5161)
	Stromboli MC 851 ○	FM	304,50 (5001)	343,80 (5001)	452,80 (5141)	438,80 (5141)	445,80 (5141)	561,80 (5141)	529,80 (5141)
CARRARO A. Di Giovanni	Carrarino 42- 43- 44- 290- 330-340- 390- 500 510- 565 - 640 - 708 -710 -712 -713 - 714 717 - 740 - 751	FM	292,00 (5008)	331,30 (5008)	440,30 (5167)	426,30 (5167)	433,30 (5167)	549,30 (5167)	517,30 (5167)
	Carrarino Serie 47 - 240 - 295 -524 (Attacco rapido)	FM	-	-	440,30 (5314)	426,30 (5314)	433,30 (5314)	-	-
	Serie 21 - 22 - 23 - 3200/4000 - 4200 - 5000 5500 - 7500 - 7700 - 8000 Tigre Car 3700-5500 ●	FM	-	-	525,30 (5304)	511,30 (5304)	518,30 (5304)	634,30 (5304)	602,30 (5304)

Segue

Price-list pump with control unit and fitting for agricultural machines (5...) = Code for flange only

MARCA	Tipo	APPLICAZIONE	AR 202 (VRI)	AR 252 (GR 30)	AR 30 (GI 40)	AR 303 (GR 40)	AR 403 (GR 40)	AR 50 (GI 40)	AR 503 (RM 40)
CARRARO A. Di Giovanni	Tigre serie 15 - 525 - 536 - 546 - 600 - 625 - 635 735 - 740 - 742 - 750 - 756 - 835 - 847 - 850 3200 - Super Tigre - Unicar 337 Serie 21 - 2800 4000 - 4800 - 7000 - Serie SM - 2000 - 2700 2500 - 2600 - Tigre Trans ●	FM	-	-	525,30 (5170)	511,30 (5170)	518,20 (5170)	634,30 (5170)	602,30 (5170)
	Tigre Car 3100 - Tigre Car 3700 - 4300 Cargo 34 ●	FM	-	-	525,30 (55356)	511,30 (55356)	518,20 (55356)	634,30 (55356)	602,30 (55356)
CARRARO S.p.A.	230 - 300 - 335 - 400 - 445 - 450 - 454 - 500 504 - 550 - 554 - 650 - 654 - 700 - 704 - 2500 3500 - 4000 - 4500 - 3000 - 6000 - 6300 - 6500 7000 - 7500 - 520.2 - 520.4 - 620.2 - 620.4 720.2 - 720.4 - 820.2 - 820.4 - 920.2 - 920.4 1020.2 - 1020.4 - 119.4 - 138.4 - 50.5 - 60.5	FM	-	-	440,30 (5171)	426,30 (5171)	433,30 (5171)	549,30 (5171)	517,30 (5171)
CASORZO	SU 2-3-4 - CU 3-6-125 - CU7 Nuova Vigneto	FT	-	-	440,30 (5174)	426,30 (5174)	433,30 (5174)	549,30 (5174)	517,30 (5174)
	Mustang	FM	-	-	440,30 (5221)	426,30 (5221)	433,30 (5221)	549,30 (5221)	517,30 (5221)
	Jolly	FM	-	-	440,30 (5172)	426,30 (5172)	433,30 (5172)	-	-
COLLINA	MTZ 140	Rid. 1:4,5 cod.1645 con disinnesto	-	-	641,30 (5280)	627,30 (5280)	634,30 (5280)	750,30 (5280)	718,30 (5280)
DIESSE	DS 90	Rid. 1:4,5 cod.1645 con disinnesto	-	-	641,30 (5280)	627,30 (5280)	634,30 (5280)	750,30 (5280)	718,30 (5280)
	DS 14 - DS 72 - DS 73 - DS 83 - DS 84 Ercole - Ercolino - Orsetto	Rid. 1:4,5 cod.1645 con disinnesto	-	-	641,30 (5160)	627,30 (5160)	634,30 (5160)	750,30 (5160)	718,30 (5160)
DURSO	Motoagricola Futura	FM	-	-	440,30 (5218)	426,30 (5218)	433,30 (5218)	549,30 (5218)	517,30 (5218)
ERREPI	Rimorchio RTS 120 RTN 300 - 500	Giunto e piedi	-	-	395,80 (5182)	381,80 (5182)	388,80 (5182)	-	472,80 (5182)
EURO WORLD GREEN	514 - 572 - 573 - 583 - 584 Presca 16 UNI 221	Rid. 1:4,5 cod.1645 con disinnesto	-	-	641,30 (5160)	627,30 (5160)	634,30 (5160)	750,30 (5160)	718,30 (5160)

Segue

Price-list pump with control unit and fitting for agricultural machines (5...) = Code for flange only



MARCA	Tipo	APPLICAZIONE	AR 202 (VRI)	AR 252 (GR 30)	AR 30 (GI 40)	AR 303 (GR 40)	AR 403 (GR 40)	AR 50 (GI 40)	AR 503 (RM 40)
EURO WORLD GREEN	594 - G 94 Presa 13 UNI 221	Rid. 1:4,5 cod.1645 con disinnesto	-	-	641,30 (5280)	627,30 (5280)	634,30 (5280)	750,30 (5280)	718,30 (5280)
EURO GARDEN	Sierra - Tucano - Tucano Super Drago - Rekord - Titano	○ FM	304,50 (5001)	343,80 (5001)	452,80 (5141)	438,80 (5141)	445,80 (5141)	561,80 (5141)	529,80 (5141)
	Jolly	FM	-	-	440,30 (5313)	426,30 (5313)	433,30 (5313)	-	-
EURO SYSTEMS	61 - 71 - 91 - 102 - 102D - 132D - 218 P75 - P80 - P100 - P130 - P140 - P180 California 1400 - 1800 - Florida 1400 - 1800	FM	-	-	440,30 (5179)	426,30 (5179)	433,30 (5179)	549,30 (5179)	517,30 (5179)
	P 105	FM	292,00 (5016)	331,30 (5016)	440,30 (5323)	426,30 (5323)	433,30 (5323)	549,30 (5323)	517,30 (5323)
	P75 -P80 -P100 -P130 California 1400 - 1800 P140 - P180 Florida 1400 -1800 -218	FM	-	-	440,30 (5151)	426,30 (5151)	433,30 (5151)	549,30 (5151)	517,30 (5151)
	90D - 110 - 110D - 140D	Rid. 1:4,5 cod.1645 con disinnesto	-	-	641,30 (5160)	627,30 (5160)	634,30 (5160)	750,30 (5160)	718,30 (5160)
	102/3 - 71/3 - 81/D	Rid. 1:4,5 cod.1645 con disinnesto	-	-	641,30 (5298)	627,30 (5298)	634,30 (5298)	750,30 (5298)	718,30 (5298)
	P 70	FM	-	-	440,30 (5296)	426,30 (5296)	433,30 (5296)	549,30 (5296)	517,30 (5296)
	Mini EFFE 901 - 902	FM	-	-	440,30 (5295)	426,30 (5295)	433,30 (5295)	549,30 (5295)	517,30 (5295)
	DT 218 - DT 226	FT	-	-	440,30 (5286)	426,30 (5286)	433,30 (5286)	549,30 (5286)	517,30 (5286)
F.B.	Serie 410 - 1200 - 1300 -1600 Tucano Super	○ FM	304,50 (5001)	343,80 (5001)	452,80 (5141)	438,80 (5141)	445,80 (5141)	561,80 (5141)	529,80 (5141)
	Serie 1400 - 1800	○ FM	-	-	452,80 (5139)	438,80 (5139)	445,80 (5139)	561,80 (5139)	529,80 (5139)
	MTZ 900	Rid. 1:4,5 cod.1645 con disinnesto	-	-	641,30 (5280)	627,30 (5280)	634,30 (5280)	750,30 (5280)	718,30 (5280)

Segue

Price-list pump with control unit and fitting for agricultural machines (5...) = Code for flange only

MARCA	Tipo	APPLICAZIONE	AR 202 (VRI)	AR 252 (GR 30)	AR 30 (GI 40)	AR 303 (GR 40)	AR 403 (GR 40)	AR 50 (GI 40)	AR 503 (RM 40)
F.B.	MTZ 1000 - MTZ 10RT - Serie 1000 1500 - 2000	Rid. 1:4,5 cod.1645 con disinnesto	-	-	641,30 (5140)	627,30 (5140)	634,30 (5140)	750,30 (5140)	718,30 (5140)
FERRANTE	F56DS - F90DS - F103DS - F 112	Giunto e piedi	-	-	395,80 (5182)	381,80 (5182)	388,80 (5182)	-	472,80 (5182)
FERRARI	32 - 34 - 34E - MC 68 - 71 - 72 - 72S - 72T 73 - 90 - 91 - 92 - 93M	FM	-	-	440,30 (5179)	426,30 (5179)	433,30 (5179)	549,30 (5179)	517,30 (5179)
	305 - 306 - 307 - 90SLB - 792 - 794	○ FM	304,50 (5002)	343,80 (5002)	452,80 (5144)	438,80 (5144)	445,80 (5144)	561,80 (5144)	529,80 (5144)
	800 - 1100	FT	-	-	440,30 (5286)	426,30 (5286)	433,30 (5286)	549,30 (5286)	517,30 (5286)
	MC 320 - 330 - 340 - 500 - 510 - 520 - 530	○ FM	-	-	452,80 (5342)	438,80 (5342)	445,80 (5342)	561,80 (5342)	529,80 (5342)
	32 - 34 - 34E MC 68 - 71 - 72 - 72S - 72T - 73 - 90 91 - 92 - 93 M	FM	-	-	440,30 (5151)	426,30 (5151)	433,30 (5151)	549,30 (5151)	517,30 (5151)
	350 (Attacco rapido)	FM	-	-	440,30 (5315)	426,30 (5315)	433,30 (5315)	549,30 (5315)	517,30 (5315)
	34F	Rid. 1:4,5 cod.1645 con disinnesto	-	-	641,30 (5298)	627,30 (5298)	634,30 (5298)	750,30 (5298)	718,30 (5298)
	300 (Attacco rapido)	FM	-	-	440,30 (5296)	426,30 (5296)	433,30 (5296)	549,30 (5296)	517,30 (5296)
	790	FM	-	-	440,30 (5295)	426,30 (5295)	433,30 (5295)	549,30 (5295)	517,30 (5295)
	305 - 306 - 792 - 794 - 90 SLB 307	○ FM	304,50 (5002)	343,80 (5002)	452,80 (5144)	438,80 (5144)	445,80 (5144)	561,80 (5144)	529,80 (5144)
FORT	Centauro 90 - Corsaro 118	○ FM	-	-	452,80 (5139)	438,80 (5139)	445,80 (5139)	561,80 (5139)	529,80 (5139)
	Leone - Universal - Tigrotto S3 Super Tigre	Rid. 1:4,5 cod.1645 con disinnesto	-	-	641,30 (5160)	627,30 (5160)	634,30 (5160)	750,30 (5160)	718,30 (5160)

Segue

Price-list pump with control unit and fitting for agricultural machines (5...) = Code for flange only



MARCA	Tipo	APPLICAZIONE	AR 202 (VRI)	AR 252 (GR 30)	AR 30 (GI 40)	AR 303 (GR 40)	AR 403 (GR 40)	AR 50 (GI 40)	AR 503 (RM 40)
FORT	Tigrotto - El Tigre	Rid. 1:4,5 cod.1645 con disinnesto	-	-	641,30 (5288)	627,30 (5288)	634,30 (5288)	750,30 (5288)	718,30 (5288)
	Minitigre - 145	Rid. 1:4,5 cod.1645 con disinnesto	-	-	641,30 (5269)	627,30 (5269)	634,30 (5269)	750,30 (5269)	718,30 (5269)
F.M. MATRAS	A - A3 - S160 - 125	FM	-	-	440,30 (5200)	426,30 (5200)	433,30 (5200)	-	-
	R 100	◆ Rid. 1:4,5 cod.1645 con disinnesto	-	-	676,30 (5201)	662,30 (5201)	669,30 (5201)	785,30 (5201)	753,30 (5201)
	L300 - R4	◆ Rid. 1:4,5 cod.1645 con disinnesto	-	-	676,30 (5202)	662,30 (5202)	669,30 (5202)	785,30 (5202)	753,30 (5202)
	MT10	○ FM	304,50 (5001)	343,80 (5001)	452,80 (5141)	438,80 (5141)	445,80 (5141)	561,80 (5141)	529,80 (5141)
	MT14	○ FM	-	-	452,80 (5139)	438,80 (5139)	445,80 (5139)	561,80 (5139)	529,80 (5139)
	R 5 - 430 - 440 - 450	Rid. 1:4,5 cod.1645 con disinnesto	-	-	641,30 (5160)	627,30 (5160)	634,30 (5160)	750,30 (5160)	718,30 (5160)
	820	○ FM	-	-	452,80 (5287)	438,80 (5287)	445,80 (5287)	561,80 (5287)	529,80 (5287)
	Mondial Serie 100 -107 -108 -110 -111 Serie 600 -608 -610 -611 FC80 -FC90 -Jolly -Jolly Super FC90 D -Jolly Professional	○ FM	304,50 (5001)	343,80 (5001)	452,80 (5141)	438,80 (5141)	445,80 (5141)	561,80 (5141)	529,80 (5141)
Ercole Export Super -Special Lux - 118 Monor 120-122-124-126-128-130 142-149-140-144-500-518-520-526T 521-530T-716-718-719-Lux 528-532	○ FM	-	-	452,80 (5139)	438,80 (5139)	445,80 (5139)	561,80 (5139)	529,80 (5139)	
Universal 224-228-230-233-236-238-240 Serie 400-426-433-828-833-834-919-921-926 928-1040-1045-1050-932-933-1038-530T-945 Euro RS22-26-30 Motoagricole Transcar W 40 - 45 - 50 - W 55 - W 60 (p.t.o. superiore a 3 fori albero 1"3/8)	FM	-	-	440,30 (5204)	426,30 (5204)	433,30 (5204)	549,30 (5204)	517,30 (5204)	

Segue

Price-list pump with control unit and fitting for agricultural machines (5...) = Code for flange only

MARCA	Tipo	APPLICAZIONE	AR 202 (VRI)	AR 252 (GR 30)	AR 30 (GI 40)	AR 303 (GR 40)	AR 403 (GR 40)	AR 50 (GI 40)	AR 503 (RM 40)
GOLDONI	Universal 224-228-230-233-236-238-240 Serie 400-426-433-919-921-926-928 1040-1045-1050 Motoagricole ○ Trasport 336-932-933-1038 Transcar 25-28-33 (presa di forza inferiore a 4 fori albero 26-30-6)	FM	-	-	452,80 (5205)	438,80 (5205)	445,80 (5205)	561,80 (5205)	529,80 (5205)
	Jolly Junior - Jolly Super - Jolly Professional Serie Uno (Senza attacco rapido)	FM	292,00 (5016)	331,30 (5016)	-	-	-	-	-
	Jolly Junior - Jolly Super - Jolly Professional Serie Uno (Attacco rapido) - Multi Hobby ○	FM (VRI)	AR DUE 241,00 (5021)	-	452,80 (5323)	438,80 (5323)	445,80 (5323)	561,80 (5323)	529,80 (5323)
GRILLO	MTZ 12000	Rid. 1:4,5 cod.1645 con disinnesto	-	-	641,30 (5340)	627,30 (5340)	634,30 (5340)	750,30 (5340)	718,30 (5340)
	Grillo GN8 - 10 - 12 - 14 - 128 - 129 129 - 131	FM	-	-	440,30 (5143)	426,30 (5143)	433,30 (5143)	549,30 (5143)	517,30 (5143)
	Grillo G131 (1000 G/1')	Rid. 1:2,6 cod.1646 con disinnesto	-	-	667,30 (5143)	653,30 (5143)	660,30 (5143)	776,30 (5143)	744,30 (5143)
	Nuovo Grillino BL - BC - 125 - 126 127 - 107 - G85 - G107 - 4 BIS - 7 BIS ○	FM	304,50 (5002)	343,80 (5002)	452,80 (5144)	438,80 (5144)	445,80 (5144)	561,80 (5144)	529,80 (5144)
	9000 - 15000	Rid. 1:4,5 cod.1645 con disinnesto	-	-	641,30 (5135)	627,30 (5135)	634,30 (5135)	750,30 (5135)	718,30 (5135)
	11000 - 11500 - 2500 - 3500	Rid. 1:4,5 cod.1645 con disinnesto	-	-	641,30 (5240)	627,30 (5240)	634,30 (5240)	750,30 (5240)	718,30 (5240)
	Zip - Zip (Attacco Rapido) Fior Fiore - G 52 - G 55	FM	292,00 (5017)	331,30 (5017)	-	-	-	-	-
	Motoagricola 131	T	292,00 (1499)	331,30 (1499)	440,30 (1509)	426,30 (1509)	433,30 (1509)	549,30 (1509)	517,30 (1509)
HONDA	F610T - F660T - F810T - F600 - F720	FM	292,00 (5023)	331,30 (5023)	-	-	-	-	-
	F510 - F560T	FM	292,00 (5024)	331,30 (5024)	-	-	-	-	-



Price-list pump with control unit and fitting for agricultural machines (5...) = Code for flange only

MARCA	Tipo	APPLICAZIONE	AR 202 (VRI)	AR 252 (GR 30)	AR 30 (GI 40)	AR 303 (GR 40)	AR 403 (GR 40)	AR 50 (GI 40)	AR 503 (RM 40)
IMAR	Omega P.d.F. superiore	Rid. 1:4,5 cod.1645 con disinnesto	-	-	641,30 (5159)	627,30 (5159)	634,30 (5159)	750,30 (5159)	718,30 (5159)
	Omega P.d.F. inferiore	FM	-	-	440,30 (5265)	426,30 (5265)	433,30 (5265)	549,30 (5265)	517,30 (5265)
	Saturnio - Sirio	FM	-	-	440,30 (5151)	426,30 (5151)	433,30 (5151)	549,30 (5151)	517,30 (5151)
	Sigma	Rid. 1:4,5 cod.1645 con disinnesto	-	-	641,30 (5240)	627,30 (5240)	634,30 (5240)	750,30 (5240)	718,30 (5240)
	Sigma 200	Rid. 1:4,5 cod.1645 con disinnesto	-	-	641,30 (5289)	627,30 (5289)	634,30 (5289)	750,30 (5289)	718,30 (5289)
ITRIA	Universale	Rid. 1:4,5 cod.1645 con disinnesto	-	-	641,30 (5298)	627,30 (5298)	634,30 (5298)	750,30 (5298)	718,30 (5298)
JONICA	Ragno	FM	-	-	440,30 (5268)	426,30 (5268)	433,30 (5268)	-	-
	Pantera	Rid. 1:4,5 cod.1645 con disinnesto	-	-	641,30 (5160)	627,30 (5160)	634,30 (5160)	750,30 (5160)	718,30 (5160)
LAMPA-CRESCIA	DL 10	Rid. 1:4,5 cod.1645 con disinnesto	-	-	641,30 (5269)	627,30 (5269)	634,30 (5269)	750,30 (5269)	718,30 (5269)
	DL 10 Super	Rid. 1:4,5 cod.1645 con disinnesto	-	-	641,30 (5257)	627,30 (5257)	634,30 (5257)	750,30 (5257)	718,30 (5257)
	DL8 - Volpino - Castoro 3+1 M Castoro Super 3+1 M	FM	292,00 (5011)	331,30 (5011)	440,30 (5250)	426,30 (5250)	433,30 (5250)	549,30 (5250)	517,30 (5250)
	Bufalo ○	FM	-	-	452,80 (5256)	438,80 (5256)	445,80 (5256)	561,80 (5256)	529,80 (5256)
	Kombi 98-FC 35 (Attacco rapido)	FM	292,00 (55361)	331,30 (55361)	440,30 (5299)	426,30 (5299)	433,30 (5299)	549,30 (5299)	517,30 (5299)
	Volpino 95 - 95 DF Castoro 3+3 M/DF Castoro Super 4+3 M	FM ○	304,50 (5002)	343,80 (5002)	452,80 (5144)	438,80 (5144)	445,80 (5144)	561,80 (5144)	529,80 (5144)

Price-list pump with control unit and fitting for agricultural machines (5...) = Code for flange only

MARCA	Tipo	APPLICAZIONE	AR 202 (VRI)	AR 252 (GR 30)	AR 30 (GI 40)	AR 303 (GR 40)	AR 403 (GR 40)	AR 50 (GI 40)	AR 503 (RM 40)
LEO	614 ○	FM	-	-	452,80 (5139)	438,80 (5139)	445,80 (5139)	561,80 (5139)	529,80 (5139)
	809 - 810 ○	FM	304,50 (5001)	343,80 (5001)	452,80 (5141)	438,80 (5141)	445,80 (5141)	561,80 (5141)	529,80 (5141)
	M4 HP10-12-14	Rid. 1:4,5 cod.1645 con disinnesto	-	-	641,30 (5154)	627,30 (5154)	634,30 (5154)	750,30 (5154)	718,30 (5154)
LEOMAR	Motoagricola R.18 - R.26 - L30 - L42	Giunto e Piedi	-	-	395,80 (5302)	381,80 (5302)	388,80 (5302)	-	472,80 (5302)
LUCCARINI	2P - Rimorchio	FM	-	-	440,30 (5218)	426,30 (5218)	433,30 (5218)	-	-
	2P - Rimorchio	Giunto e Piedi	-	-	395,80 (5273)	381,80 (5273)	388,80 (5273)	-	-
M.A.B.	Panda 210-212-NP2 -135	FM	-	-	440,30 (5307)	426,30 (5307)	433,30 (5307)	549,30 (5307)	517,30 (5307)
	T3 - NF1 - Nuova Formica ◆	Rid. 1:4,5 cod.1645 con disinnesto	-	-	676,30 (5158)	662,30 (5158)	669,30 (5158)	785,30 (5158)	753,30 (5158)
	Talpina - Ghiro	FM	-	-	440,30 (5156)	426,30 (5156)	433,30 (5156)	549,30 (5156)	517,30 (5156)
	Formica T4 HP 8-10	Rid. 1:4,5 cod.1645 con disinnesto	-	-	641,30 (5159)	627,30 (5159)	634,30 (5159)	750,30 (5159)	718,30 (5159)
MG	Ercole -Ariete - Daino	Rid. 1:4,5 cod.1645 con disinnesto	-	-	641,30 (5140)	627,30 (5140)	634,30 (5140)	750,30 (5140)	718,30 (5140)
M.GI.BI.	Motozappa HP 8-10-12-14- M4 - M5 - M6	Rid. 1:4,5 cod.1645 con disinnesto	-	-	641,30 (5203)	627,30 (5203)	634,30 (5203)	750,30 (5203)	718,30 (5203)
	Motozappa 20	Rid. 1:4,5 cod.1645 con disinnesto	-	-	641,30 (5240)	627,30 (5240)	634,30 (5240)	750,30 (5240)	718,30 (5240)
	Rimorchio Motrice	FM	-	-	440,30 (5325)	426,30 (5325)	433,30 (5325)	549,30 (5325)	517,30 (5325)

Segue



Price-list pump with control unit and fitting for agricultural machines (5...) = Code for flange only

MARCA	Tipo	APPLICAZIONE	AR 202 (VRI)	AR 252 (GR 30)	AR 30 (GI 40)	AR 303 (GR 40)	AR 403 (GR 40)	AR 50 (GI 40)	AR 503 (RM 40)
M.GI.BI.	Rimorchio motrice (Tipo Idropompe)	FM	-	-	440,30 (5278)	426,30 (5278)	433,30 (5278)	549,30 (5278)	517,30 (5278)
MIRA	Rosita	Rid. 1:4,5 cod.1645 con disinnesto	-	-	641,30 (5280)	627,30 (5280)	634,30 (5280)	750,30 (5280)	718,30 (5280)
	Special ○	FM	-	-	452,80 (5139)	438,80 (5139)	445,80 (5139)	561,80 (5139)	529,80 (5139)
	Simone ○	FM	304,50 (5001)	343,80 (5001)	452,80 (5141)	438,80 (5141)	445,80 (5141)	561,80 (5141)	529,80 (5141)
MONDIAL	Italia - America - Super America	Rid. 1:4,5 cod.1645 con disinnesto	-	-	641,30 (5160)	627,30 (5160)	634,30 (5160)	750,30 (5160)	718,30 (5160)
	Elba	Rid. 1:4,5 cod.1645 con disinnesto	-	-	641,30 (5269)	627,30 (5269)	634,30 (5269)	750,30 (5269)	718,30 (5269)
NIBBI BRUNO	Artiglio B - Artiglio E - G519 - FOX600 FOX700- G719- G520- G521- G521S FOX800 - MAK 8	FM	-	-	440,30 (5221)	426,30 (5221)	433,30 (5221)	549,30 (5221)	517,30 (5221)
	Artiglio G - G119 - G319	FM	-	-	440,30 (5223)	426,30 (5223)	433,30 (5223)	549,30 (5223)	517,30 (5223)
	Motoagricola Art.E - G519- G521 G521 S	FM	-	-	440,30 (5228)	426,30 (5228)	433,30 (5228)	549,30 (5228)	517,30 (5228)
	NTR 350	Rid. 1:4,5 cod.1645 con disinnesto	-	-	641,30 (55362)	627,30 (55362)	634,30 (55362)	-	-
	Top 108 - Max 105 / 108 / 110 / 206 / 305 624 / 625 (Attacco rapido)	FM	-	-	440,30 (5316)	426,30 (5316)	433,30 (5316)	549,30 (5316)	517,30 (5316)
NIBBI DECIMO	Grifo 3000	FM	-	-	440,30 (5244)	426,30 (5244)	433,30 (5244)	549,30 (5244)	517,30 (5244)
	34 (Attacco rapido)	FM	-	-	440,30 (5316)	426,30 (5316)	433,30 (5316)	549,30 (5316)	517,30 (5316)
	Grifo Extra - G.22	Rid. 1:4,5 cod.1645 con disinnesto	-	-	641,30 (5154)	627,30 (5154)	634,30 (5154)	750,30 (5154)	718,30 (5154)

Segue

Price-list pump with control unit and fitting for agricultural machines (5. . .) = Code for flange only

MARCA	Tipo	APPLICAZIONE	AR 202 (VRI)	AR 252 (GR 30)	AR 30 (GI 40)	AR 303 (GR 40)	AR 403 (GR 40)	AR 50 (GI 40)	AR 503 (RM 40)
NIBBI DECIMO	G.28	Rid. 1:4,5 cod.1645 con disinnesto	-	-	641,30 (5317)	627,30 (5317)	634,30 (5317)	750,30 (5317)	718,30 (5317)
	Astro	Rid. 1:4,5 cod.1645 con disinnesto	-	-	641,30 (5280)	627,30 (5280)	634,30 (5280)	750,30 (5280)	718,30 (5280)
NUOVA FIM	Urano - Plutone - Nettuno	○ FM	-	-	452,80 (5139)	438,80 (5139)	445,80 (5139)	561,80 (5139)	529,80 (5139)
	Ariete - Vulcano - Vulcano 2	Rid. 1:4,5 cod.1645 con disinnesto	-	-	641,30 (5140)	627,30 (5140)	634,30 (5140)	750,30 (5140)	718,30 (5140)
	Saturno Super - Giove Nuovo Saturno Super	○ FM	304,50 (5001)	343,80 (5001)	452,80 (5141)	438,80 (5141)	445,80 (5141)	561,80 (5141)	529,80 (5141)
	M74-75	Rid. 1:4,5 cod.1645 con disinnesto	-	-	641,30 (5160)	627,30 (5160)	634,30 (5160)	750,30 (5160)	718,30 (5160)
ORMAG	MD78 - MD79	FM	-	-	440,30 (5151)	426,30 (5151)	433,30 (5151)	549,30 (5151)	517,30 (5151)
	608	○ FM	304,50 (5001)	343,80 (5001)	452,80 (5141)	438,80 (5141)	445,80 (5141)	561,80 (5141)	529,80 (5141)
PASBO	MT9 - Bongo - 614 - 618	○ FM	-	-	452,80 (5139)	438,80 (5139)	445,80 (5139)	561,80 (5139)	529,80 (5139)
	G 11	Rid. 1:4,5 cod.1645 con disinnesto	-	-	641,30 (5230)	627,30 (5230)	634,30 (5230)	750,30 (5230)	718,30 (5230)
	G 14 - G 72 - G 73 - G 83 - 84 - 93	Rid. 1:4,5 cod.1645 con disinnesto	-	-	641,30 (5160)	627,30 (5160)	634,30 (5160)	750,30 (5160)	718,30 (5160)
	G 94	Rid. 1:4,5 cod.1645 con disinnesto	-	-	641,30 (5280)	627,30 (5280)	634,30 (5280)	750,30 (5280)	718,30 (5280)
	PASQUALI	XB 60	FM	-	-	440,30 (5151)	426,30 (5151)	433,30 (5151)	549,30 (5151)
901-903-907-909-911-912-913-914-916-917 918-919-921-922-923-924-933-934-949		FM	-	-	440,30 (5231)	426,30 (5231)	433,30 (5231)	549,30 (5231)	517,30 (5231)

Segue

Price-list pump with control unit and fitting for agricultural machines (5...) = Code for flange only



MARCA	Tipo	APPLICAZIONE	AR 202 (VRI)	AR 252 (GR 30)	AR 30 (GI 40)	AR 303 (GR 40)	AR 403 (GR 40)	AR 50 (GI 40)	AR 503 (RM 40)
PASQUALI	Rimorchio 901-903-907-909-911-912 913-914-916-917-918-919-921-922 923-924-933-934-949	◆ FM	-	-	475,30 (5291)	461,30 (5291)	468,30 (5291)	584,30 (5291)	552,30 (5291)
	938-939-952-953-461-465 (478 fino alla matricola 729)	○ FM	304,50 (5002)	343,80 (5002)	452,80 (5144)	438,80 (5144)	445,80 (5144)	561,80 (5144)	529,80 (5144)
	900-904-906-908-910-930-931-935-937-940 941-944-945-946-947-956-957-959-965-970 971-975-976-979-985-986-988-990-991-993 995-996-997-957/20-49-439-454-493-946T 947T-956T-957T-959T-994-487	○ FM (Tipo lungo)	-	-	452,80 (5232)	438,80 (5232)	445,80 (5232)	561,80 (5232)	529,80 (5232)
	401-402-404-406-412-490-498-499 - XR Series 95 -496 (Attacco rapido) - SR Series	FM	-	-	440,30 (5315)	426,30 (5315)	433,30 (5315)	549,30 (5315)	517,30 (5315)
	478 (Dalla Matricola 730)	FM	-	-	440,30 (5303)	426,30 (5303)	433,30 (5303)	549,30 (5303)	517,30 (5303)
	XB40 - SB30 - SB40	○ FM	-	-	452,80 (5342)	438,80 (5342)	445,80 (5342)	561,80 (5342)	529,80 (5342)
PEGORARO	Quick 850 - Professional 1200	○ FM	-	-	452,80 (5256)	438,80 (5256)	445,80 (5256)	561,80 (5256)	529,80 (5256)
	Quick 850 - Professional 1200 (Attacco rapido)	FM	-	-	440,30 (5300)	426,30 (5300)	433,30 (5300)	549,30 (5300)	517,30 (5300)
PGS	L15-F12-F13-F14-F16-F18-Attila-Rekord Sparta-Export-Super HP15-F803	○ FM	-	-	452,80 (5234)	438,80 (5234)	445,80 (5234)	561,80 (5234)	529,80 (5234)
	Attila Super	□ FM	-	-	470,30 (5235)	456,30 (5235)	463,30 (5235)	579,30 (5235)	547,30 (5235)
QUERZOLA	Motocoltivatore HP 10 - 11	○ FM	304,50 (5001)	343,80 (5001)	452,80 (5141)	438,80 (5141)	445,80 (5141)	561,80 (5141)	529,80 (5141)
	Motozappa HP 10 - 11	Rid. 1:4,5 cod.1645 con disinnesto	-	-	641,30 (5135)	627,30 (5135)	634,30 (5135)	750,30 (5135)	718,30 (5135)

Price-list pump with control unit and fitting for agricultural machines (5 . . .) = Code for flange only

MARCA	Tipo	APPLICAZIONE	AR 202 (VRI)	AR 252 (GR 30)	AR 30 (GI 40)	AR 303 (GR 40)	AR 403 (GR 40)	AR 50 (GI 40)	AR 503 (RM 40)
RANDI	129	Rid. 1:4,5 cod.1645 con disinnesto	-	-	641,30 (5280)	627,30 (5280)	634,30 (5280)	750,30 (5280)	718,30 (5280)
	Serie 650	FM	-	-	440,30 (5156)	426,30 (5156)	433,30 (5156)	549,30 (5156)	517,30 (5156)
	2000	Rid. 1:4,5 cod.1645 con disinnesto	-	-	641,30 (5154)	627,30 (5154)	634,30 (5154)	750,30 (5154)	718,30 (5154)
	2500 - 3000 - 3500 - 3600 - 4000 6000 - RA 24 - 4R	FM	-	-	440,30 (5121)	426,30 (5121)	433,30 (5121)	549,30 (5121)	517,30 (5121)
	MTZ 128	Rid. 1:4,5 cod.1645 con disinnesto	-	-	641,30 (5240)	627,30 (5240)	634,30 (5240)	750,30 (5240)	718,30 (5240)
ROTECO	Mod.109 - 110 - 111 - 114 - 116 - 118 Robby - Duran - Triss - Super Triss	FM	-	-	440,30 (5151)	426,30 (5151)	433,30 (5151)	549,30 (5151)	517,30 (5151)
	310 - 314D	Rid. 1:4,5 cod.1645 con disinnesto	-	-	641,30 (5288)	627,30 (5288)	634,30 (5288)	750,30 (5288)	718,30 (5288)
R.V.M.	Motoagricola	Rid. 1:2,6 cod.1646 con disinnesto	-	-	667,30 (5229)	653,30 (5229)	660,30 (5229)	776,30 (5229)	744,30 (5229)
SAME	DA 30 - 240 - 250 - 450	FT	-	-	440,30 (5247)	426,30 (5247)	433,30 (5247)	549,30 (5247)	517,30 (5247)
SEP	70 - 80 - 200 - 1000 - 1300 - 1500 1600 - MFC 150 Smart	FM	292,00 (5011)	331,30 (5011)	440,30 (5250)	426,30 (5250)	433,30 (5250)	549,30 (5250)	517,30 (5250)
	MTA 135-MTA 135 RS- 140 -MZRTM1 RDS - 236 RS - Rimorchio SEP 130 - 140 MTA 136 RS-Rimorchio SEP 115 - 125	FM	-	-	440,30 (5251)	426,30 (5251)	433,30 (5251)	549,30 (5251)	517,30 (5251)
	RM Reversibile	FM	-	-	440,30 (5254)	426,30 (5254)	433,30 (5254)	549,30 (5254)	517,30 (5254)
	2500 ○	FM	-	-	452,80 (5252)	438,80 (5252)	445,80 (5252)	561,80 (5252)	529,80 (5252)
	5000	FM	-	-	440,30 (5255)	426,30 (5255)	433,30 (5255)	549,30 (5255)	517,30 (5255)

Segue

Price-list pump with control unit and fitting for agricultural machines (5...) = Code for flange only



MARCA	Tipo	APPLICAZIONE	AR 202 (VRI)	AR 252 (GR 30)	AR 30 (GI 40)	AR 303 (GR 40)	AR 403 (GR 40)	AR 50 (GI 40)	AR 503 (RM 40)
SEP	6000 - 2300 - 3000 Reversibile ○	FM	-	-	452,80 (5256)	438,80 (5256)	445,80 (5256)	561,80 (5256)	529,80 (5256)
	100 - 110 - 120 - 130	Rid. 1:4,5 cod.1645 con disinnesto	-	-	641,30 (5257)	627,30 (5257)	634,30 (5257)	750,30 (5257)	718,30 (5257)
	105 - 115 - 125 - 103 - 113 - 114	Rid. 1:4,5 cod.1645 con disinnesto	-	-	641,30 (5269)	627,30 (5269)	634,30 (5269)	750,30 (5269)	718,30 (5269)
	MFC 150 - 160 - 180 - 186 - 1000 (presa att. rapido) MFL 150	FM	292,00 (55360)	331,30 (55360)	440,30 (5282)	426,30 (5282)	433,30 (5282)	549,30 (5282)	517,30 (5282)
	MCF 220 - S 1300 Special - S 1500 S 1500 Special - S 1600 (presa att. rapido) 3000	FM	-	-	440,30 (5300)	426,30 (5300)	433,30 (5300)	549,30 (5300)	517,30 (5300)
	138 - 132 ◆	Rid. 1:4,5 cod.1645 con disinnesto	-	-	676,30 (5305)	-	-	-	-
	SMART-BC 90 - BL 90 (presa att. rapido)	FM	292,00 (55361)	331,30 (55361)	-	426,30 (5299)	-	-	-
	1400 - 1400 Special - REV 1700 ○ REV 1700 Special - MFC 226 - MFC 226 Special (att. rapido) - REV 1900	FM	-	-	452,80 (5329)	438,80 (5329)	445,80 (5329)	561,80 (5329)	529,80 (5329)
STRACCINI	Moltiplicatore	FM	-	-	440,30 (5309)	426,30 (5309)	433,30 (5309)	549,30 (5309)	517,30 (5309)
VALENTINI	C410 - Alfa 20 - 26 - 33 Beta 30 - P 104	FM	-	-	440,30 (5258)	426,30 (5258)	433,30 (5258)	549,30 (5258)	517,30 (5258)
VALPADANA	VMC 10	FM	-	-	440,30 (5254)	426,30 (5254)	433,30 (5254)	549,30 (5254)	517,30 (5254)
	VMC 12	FM	-	-	440,30 (5255)	426,30 (5255)	433,30 (5255)	549,30 (5255)	517,30 (5255)
	VMC 14-4RM180- 4RM 260 - VMC 180RDV MTA 180-260-1014-1016 Fino serie 050897 (1326-2030 Elegant fino matr.30999) ○ Blitz 150	FM	-	-	452,80 (5252)	438,80 (5252)	445,80 (5252)	561,80 (5252)	529,80 (5252)
	VMZ 14 - VMZ 135 - VMA 135	FM	-	-	440,30 (5251)	426,30 (5251)	433,30 (5251)	549,30 (5251)	517,30 (5251)

Segue

Price-list pump with control unit and fitting for agricultural machines (5...) = Code for flange only

MARCA	Tipo	APPLICAZIONE	AR 202 (VRI)	AR 252 (GR 30)	AR 30 (GI 40)	AR 303 (GR 40)	AR 403 (GR 40)	AR 50 (GI 40)	AR 503 (RM 40)	
VALPADANA	VMC 18 - 4RM18 - 4RM 20 4RM 24 Vecchio tipo	○	FT	-	-	452,80 (5260)	438,80 (5260)	445,80 (5260)	561,80 (5260)	529,80 (5260)
	VMC90-VMC100-VMC110-VMC120-VMC130 VMC135-VMF250-VMZ7-VMZ8-VMC65		FM	292,00 (5011)	331,30 (5011)	440,30 (5250)	426,30 (5250)	433,30 (5250)	549,30 (5250)	517,30 (5250)
	MTA20/26-MTA20/33-VMC18RDV-4RM20 2533 - 2536-24-26-300-330 Nuovo tipo 1533-1540-1526	●	FM	-	-	525,30 (5263)	511,30 (5263)	518,30 (5263)	634,30 (5263)	602,30 (5263)
	VMZ 9 - VMZ 11		Rid. 1:4,5 cod.1645 con disinnesto	-	-	641,30 (5269)	627,30 (5269)	634,30 (5269)	750,30 (5269)	718,30 (5269)
	VMC 140 - VMC 150 - VMC 160 Blitz 70 - 80 - 120	○	FM	-	-	452,80 (5256)	438,80 (5256)	445,80 (5256)	561,80 (5256)	529,80 (5256)
	Blitz 70 - 80 - 120 (Attacco rapido)		FM	-	-	440,30 (5300)	426,30 (5300)	433,30 (5300)	549,30 (5300)	517,30 (5300)
	VMZ 10 - VMZ 12 - VMZ 13		Rid. 1:4,5 cod.1645 con disinnesto	-	-	641,30 (5257)	627,30 (5257)	634,30 (5257)	750,30 (5257)	718,30 (5257)
	VMF 150 - Presa attacco rapido		FM	292,00 (55360)	331,30 (55360)	440,30 (5282)	426,30 (5282)	433,30 (5282)	549,30 (5282)	517,30 (5282)
	VMC 65 - VMF 50 - BLITZ 50 (Presa attacco rapido)		FM	292,00 (55361)	331,30 (55361)	-	426,30 (5299)	-	-	-
	VMC 100-VMC110-VMC120-VMC135 VMF220-VMC130 (Presa attacco diretto)		FM	-	-	440,30 (5300)	426,30 (5300)	433,30 (5300)	549,30 (5300)	517,30 (5300)
	MTA1326-2030Elegant(dalla Matricola 31000) MTA1014-1016-260-180-4RM20/30-2030 RS DIAMANT (Dalla serie 050898 -Presa 21-25- UNI221) - MTA 1820 - 1825	◆	FM	-	-	475,30 (5306)	461,30 (5306)	468,30 (5306)	584,30 (5306)	552,30 (5306)
	VMZ 138	◆	Rid. 1:4,5 cod.1645 con disinnesto	-	-	676,30 (5305)	662,30 (5305)	669,30 (5305)	-	-
	230 (Attacco rapido)	○	FM	-	-	452,80 (5329)	438,80 (5329)	445,80 (5329)	561,80 (5329)	529,80 (5329)
	2030 RS- 2025WRS- 2030 4RM MTA 2030Elegant MTA 2025W Elegant MTA 2030Diamant MTA 2025W Diamant-MTA 1820Car MTA 1820 Trans (Presa di forza 1"3/8) MTA 1820 CAR		FM	-	-	440,30 (5334)	426,30 (5334)	433,30 (5334)	549,30 (5334)	517,30 (5334)

Price-list pump with control unit and fitting for agricultural machines (5...) = Code for flange only



MARCA	Tipo	APPLICAZIONE	AR 202 (VRI)	AR 252 (GR 30)	AR 30 (GI 40)	AR 303 (GR 40)	AR 403 (GR 40)	AR 50 (GI 40)	AR 503 (RM 40)
YAGMUR	Elmas 80 - Safir 120 - Zumurut 70 ○	FM	-	-	452,80 (5256)	438,80 (5256)	445,80 (5256)	561,80 (5256)	529,80 (5256)
	Elmas 80 - Safir 120 - Zumurut 70 (attacco rapido)	FM	-	-	440,30 (5300)	426,30 (5300)	433,30 (5300)	549,30 (5300)	517,30 (5300)
	Inci 50 Reversibile (attacco rapido)	FM	292,00 (55361)	331,30 (55361)	440,30 (5299)	426,30 (5299)	433,30 (5299)	549,30 (5299)	517,30 (5299)
	Yakut 150 ○	FM	-	-	452,80 (5252)	438,80 (5252)	445,80 (5252)	561,80 (5252)	529,80 (5252)

(□◆●○) Surcharge for special flange requirements

This Price-List cancels and replaces all previous ones and is subject to modification without notice. Data, description, photographs and illustrations are purely guideline and are not binding. Annovi Riverberi S.p.A. preserves the right to make partial shipments.